



NEXCOM International Co., Ltd.

Intelligent Platform & Services Business Unit

Wide Screen Touch Computer

XPPC 22-100A

User Manual

CONTENTS

Preface

Copyright	iv
Disclaimer	iv
Acknowledgements	iv
Regulatory Compliance Statements	iv
Declaration of Conformity	iv
RoHS Compliance	v
Warranty and RMA	vi
Safety Information	viii
Installation Recommendations	viii
Safety Precautions	ix
Technical Support and Assistance	x
Conventions Used in this Manual	x
Global Service Contact Information	xi
Package Contents	xiii
Ordering Information	xiv

Chapter 1: Product Introduction

XPPC 22-100A	1
Overview	1
Key Features	1
Hardware Specifications	2
Knowing Your XPPC 22-100A	4
Rear Bottom	4
Rear Top	4
Mechanical Dimensions	5

Chapter 2: Jumpers and Connectors

Before You Begin	6
Precautions	6
Jumper Settings	7
Locations of the Jumpers and Connectors for XPPC 22-100A	8
Top View	8
Bottom View	9
Jumpers & DIP Switches	10
AT/ATX Mode Select	10
Clear CMOS	10
LVDS Panel Voltage Select	11
Backlight Control Voltage Select (Dimming)	11
LVDS Resolution Select	12
Connector Pin Definitions	13
External Connector	13
COM1 DB9 Male Connector	13
Internal Connectors	14
LVDS Inverter Connector	14
System Reset Header	14
LED Connector	15
HDD LED Connector	15
Line-out Connector	16
USB Connector	16
USB Touch	17
System Power Button Header	17
DC Power Input	18



- FAN Connector 18
- Debug Port/LPC Bus Connector 19
- COM Port Connector 19
- Battery Connector 20
- LVDS Panel Connector 20
- Mini-PCIe Connector 21
- M.2 Connector (M-Key) 22

Chapter 3: System Setup

- Removing the Top Cover from the Chassis 23
- Installing DDR, SSD 23
- Installing a WiFi or LTE Module 25
- Installing VESA Mount Kit 26
- Installing Open Frame Kit 26
- System Dimensions with Open Frame Kit 27
- Panel Mounting 28

Chapter 4: BIOS Setup

- About BIOS Setup 29
- When to Configure the BIOS 29
- Default Configuration 30
- Entering Setup 30
- Legends 30
- BIOS Setup Utility 32
 - Main 32
 - Advanced 33
 - Chipset 40
 - Security 43
 - Boot 44
 - Save & Exit 45

- Default Configuration 32
- Entering Setup 32
- Legends 32
- BIOS Setup Utility 34
 - Main 34
 - Advanced 35
 - Security 43
 - Boot 44
 - Save & Exit 45

PREFACE

Copyright

This publication, including all photographs, illustrations and software, is protected under international copyright laws, with all rights reserved. No part of this manual may be reproduced, copied, translated or transmitted in any form or by any means without the prior written consent from NEXCOM International Co., Ltd.

Disclaimer

The information in this document is subject to change without prior notice and does not represent commitment from NEXCOM International Co., Ltd. However, users may update their knowledge of any product in use by constantly checking its manual posted on our website: <http://www.nexcom.com>. NEXCOM shall not be liable for direct, indirect, special, incidental, or consequential damages arising out of the use of any product, nor for any infringements upon the rights of third parties, which may result from such use. Any implied warranties of merchantability or fitness for any particular purpose is also disclaimed.

Acknowledgements

XPPC 22-100A is a trademark of NEXCOM International Co., Ltd. All other product names mentioned herein are registered trademarks of their respective owners.

Regulatory Compliance Statements

This section provides the FCC compliance statement for Class A devices and describes how to keep the system CE compliant.

Declaration of Conformity

FCC

This equipment has been tested and verified to comply with the limits for a Class A digital device, pursuant to Part 15 of FCC Rules. These limits are designed to provide reasonable protection against harmful interference when the equipment is operated in a commercial environment. This equipment generates, uses, and can radiate radio frequency energy and, if not installed and used in accordance with the instructions, may cause harmful interference to radio communications. Operation of this equipment in a residential area (domestic environment) is likely to cause harmful interference, in which case the user will be required to correct the interference (take adequate measures) at their own expense.

CE

The product(s) described in this manual complies with all applicable European Union (CE) directives if it has a CE marking. For computer systems to remain CE compliant, only CE-compliant parts may be used. Maintaining CE compliance also requires proper cable and cabling techniques.

RoHS Compliance



NEXCOM RoHS Environmental Policy and Status Update

NEXCOM is a global citizen for building the digital infrastructure. We are committed to providing green products and services, which are compliant with European Union RoHS (Restriction on Use of Hazardous Substance in Electronic Equipment) directive 2011/65/EU, to be your trusted green partner and to protect our environment.

RoHS restricts the use of Lead (Pb) < 0.1% or 1,000ppm, Mercury (Hg) < 0.1% or 1,000ppm, Cadmium (Cd) < 0.01% or 100ppm, Hexavalent Chromium (Cr6+) < 0.1% or 1,000ppm, Polybrominated biphenyls (PBB) < 0.1% or 1,000ppm, and Polybrominated diphenyl Ethers (PBDE) < 0.1% or 1,000ppm.

In order to meet the RoHS compliant directives, NEXCOM has established an engineering and manufacturing task force to implement the introduction of green products. The task force will ensure that we follow the standard NEXCOM development procedure and that all the new RoHS components and new manufacturing processes maintain the highest industry quality levels for which NEXCOM are renowned.

The model selection criteria will be based on market demand. Vendors and suppliers will ensure that all designed components will be RoHS compliant.

How to recognize NEXCOM RoHS Products?

For existing products where there are non-RoHS and RoHS versions, the suffix "(LF)" will be added to the compliant product name.

All new product models launched after January 2013 will be RoHS compliant. They will use the usual NEXCOM naming convention.

Warranty and RMA

NEXCOM Warranty Period

NEXCOM manufactures products that are new or equivalent to new in accordance with industry standard. NEXCOM warrants that products will be free from defect in material and workmanship for 2 years, beginning on the date of invoice by NEXCOM.

NEXCOM Return Merchandise Authorization (RMA)

- Customers shall enclose the “NEXCOM RMA Service Form” with the returned packages.
- Customers must collect all the information about the problems encountered and note anything abnormal or, print out any on-screen messages, and describe the problems on the “NEXCOM RMA Service Form” for the RMA number apply process.
- Customers can send back the faulty products with or without accessories (manuals, cable, etc.) and any components from the card, such as CPU and RAM. If the components were suspected as part of the problems, please note clearly which components are included. Otherwise, NEXCOM is not responsible for the devices/parts.
- Customers are responsible for the safe packaging of defective products, making sure it is durable enough to be resistant against further damage and deterioration during transportation. In case of damages occurred during transportation, the repair is treated as “Out of Warranty.”
- Any products returned by NEXCOM to other locations besides the customers’ site will bear an extra charge and will be billed to the customer.

Repair Service Charges for Out-of-Warranty Products

NEXCOM will charge for out-of-warranty products in two categories, one is basic diagnostic fee and another is component (product) fee.

System Level

- Component fee: NEXCOM will only charge for main components such as SMD chip, BGA chip, etc. Passive components will be repaired for free, ex: resistor, capacitor.
- Items will be replaced with NEXCOM products if the original one cannot be repaired. Ex: motherboard, power supply, etc.
- Replace with 3rd party products if needed.
- If RMA goods can not be repaired, NEXCOM will return it to the customer without any charge.

Board Level

- Component fee: NEXCOM will only charge for main components, such as SMD chip, BGA chip, etc. Passive components will be repaired for free, ex: resistors, capacitors.
- If RMA goods can not be repaired, NEXCOM will return it to the customer without any charge.

Warnings

Read and adhere to all warnings, cautions, and notices in this guide and the documentation supplied with the chassis, power supply, and accessory modules. If the instructions for the chassis and power supply are inconsistent with these instructions or the instructions for accessory modules, contact the supplier to find out how you can ensure that your computer meets safety and regulatory requirements.

Cautions

Electrostatic discharge (ESD) can damage system components. Do the described procedures only at an ESD workstation. If no such station is available, you can provide some ESD protection by wearing an antistatic wrist strap and attaching it to a metal part of the computer chassis.

Safety Information

Before installing and using the device, note the following precautions:

- Read all instructions carefully.
- Do not place the unit on an unstable surface, cart, or stand.
- Follow all warnings and cautions in this manual.
- When replacing parts, ensure that your service technician uses parts specified by the manufacturer.
- Avoid using the system near water, in direct sunlight, or near a heating device.
- The load of the system unit does not solely rely for support from the rackmounts located on the sides. Firm support from the bottom is highly necessary in order to provide balance stability.
- The computer is provided with a battery-powered real-time clock circuit. There is a danger of explosion if battery is incorrectly replaced. Replace only with the same or equivalent type recommended by the manufacturer. Discard used batteries according to the manufacturer's instructions.

Installation Recommendations

Ensure you have a stable, clean working environment. Dust and dirt can get into components and cause a malfunction. Use containers to keep small components separated.

Adequate lighting and proper tools can prevent you from accidentally damaging the internal components. Most of the procedures that follow require only a few simple tools, including the following:

- A Philips screwdriver
- A flat-tipped screwdriver
- A grounding strap
- An anti-static pad

Using your fingers can disconnect most of the connections. It is recommended that you do not use needle-nose pliers to disconnect connections as these can damage the soft metal or plastic parts of the connectors.

Safety Precautions

1. Read these safety instructions carefully.
2. Keep this User Manual for later reference.
3. Disconnect this equipment from any AC outlet before cleaning. Use a damp cloth. Do not use liquid or spray detergents for cleaning.
4. For plug-in equipment, the power outlet socket must be located near the equipment and must be easily accessible.
5. Keep this equipment away from humidity.
6. Put this equipment on a stable surface during installation. Dropping it or letting it fall may cause damage.
7. The openings on the enclosure are for air convection to protect the equipment from overheating. DO NOT COVER THE OPENINGS.
8. Make sure the voltage of the power source is correct before connecting the equipment to the power outlet.
9. Place the power cord in a way so that people will not step on it. Do not place anything on top of the power cord. Use a power cord that has been approved for use with the product and that it matches the voltage and current marked on the product's electrical range label. The voltage and current rating of the cord must be greater than the voltage and current rating marked on the product.
10. All cautions and warnings on the equipment should be noted.
11. If the equipment is not used for a long time, disconnect it from the power source to avoid damage by transient overvoltage.
12. Never pour any liquid into an opening. This may cause fire or electrical shock.
13. Never open the equipment. For safety reasons, the equipment should be opened only by qualified service personnel.
14. If one of the following situations arises, get the equipment checked by service personnel:
 - a. The power cord or plug is damaged.
 - b. Liquid has penetrated into the equipment.
 - c. The equipment has been exposed to moisture.
 - d. The equipment does not work well, or you cannot get it to work according to the user's manual.
 - e. The equipment has been dropped and damaged.
 - f. The equipment has obvious signs of breakage.
15. Do not place heavy objects on the equipment.
16. The unit uses a three-wire ground cable which is equipped with a third pin to ground the unit and prevent electric shock. Do not defeat the purpose of this pin. If your outlet does not support this kind of plug, contact your electrician to replace your obsolete outlet.
17. **ATTENTION:** Risque d'explosion si la batterie est remplacée par un type incorrect. Mettre au rebus les batteries usagées selon les instructions.

CAUTION: Risk of explosion if battery is replaced by an incorrect type. Dispose of used batteries according to the instructions.

Technical Support and Assistance

1. For the most updated information of NEXCOM products, visit NEXCOM's website at www.nexcom.com.
2. For technical issues that require contacting our technical support team or sales representative, please have the following information ready before calling:
 - Product name and serial number
 - Detailed information of the peripheral devices
 - Detailed information of the installed software (operating system, version, application software, etc.)
 - A complete description of the problem
 - The exact wordings of the error messages

Warning!

1. Handling the unit: carry the unit with both hands and handle it with care.
2. Maintenance: to keep the unit clean, use only approved cleaning products or clean with a dry cloth.

Conventions Used in this Manual



Warning:

Information about certain situations, which if not observed, can cause personal injury. This will prevent injury to yourself when performing a task.



Caution:

Information to avoid damaging components or losing data.



Note:

Provides additional information to complete a task easily.

Global Service Contact Information

Headquarters

NEXCOM International Co., Ltd.

9F, No. 920, Zhongzheng Rd.,
Zhonghe District, New Taipei City, 23586,
Taiwan, R.O.C.
Tel: +886-2-8226-7786
Fax: +886-2-8226-7782
www.nexcom.com

Asia

Taiwan

NexAIoT Headquarters

Industry 4.0 and Cloud Services

13F, No.922, Zhongzheng Rd.,
Zhonghe District, New Taipei City,
23586, Taiwan, R.O.C.
Tel: +886-2-8226-7796
Fax: +886-2-8226-7926
Email: jacobhuang@nexaiot.com
www.nexaiot.com

NexAIoT Co., Ltd.

Taichung Office

16F, No.250, Sec.2, Chongde Rd.,
Beitun District,
Taichung City, 406, Taiwan, R.O.C.
Tel: +886-4-2249-1179
Fax: +886-4-2249-1172
Email: jacobhuang@nexaiot.com
www.nexaiot.com

NexCOBOT Taiwan Co., Ltd.

13F, No.916, Zhongzheng Rd.,
Zhonghe District,
New Taipei City, 23586, Taiwan, R.O.C.
Tel: +886-2-8226-7786
Fax: +886-2-8226-7926
Email: jennyshern@nexcobot.com
www.nexcobot.com

GreenBase Technology Corp.

13F, No.922, Zhongzheng Rd.,
Zhonghe District,
New Taipei City, 23586, Taiwan, R.O.C.
Tel: +886-2-8226-7786
Fax: +886-2-8226-7900
Email: vivianlin@nexcom.com.tw
www.nexcom.com.tw

DivioTec Inc.

19F-1A, No.97, Sec.4, ChongXin Rd.,
Sanhong District,
New Taipei City, 24161, Taiwan, R.O.C.
Tel: +886-2-8976-3077
Email: sales@diviotec.com
www.diviotec.com

AIoT Cloud Corp.

13F, No.922, Zhongzheng Rd.,
Zhonghe District,
New Taipei City, 23586, Taiwan, R.O.C.
Tel: +886-2-8226-7786
Fax: +886-2-8226-7782
Email: alantsai@aiotcloud.net
www.aiotcloud.dev

EMBUX TECHNOLOGY CO., LTD.

13F, No.916, Zhongzheng Rd.,
Zhonghe District,
New Taipei City, 23586, Taiwan, R.O.C.
Tel: +886-2-8226-7786
Fax: +886-2-8226-7782
Email: info@embux.com
www.embux.com

TMR TECHNOLOGIES CO., LTD.

13F, No.916, Zhongzheng Rd.,
Zhonghe District,
New Taipei City, 23586, Taiwan, R.O.C.
Tel: +886-2-8226-7786
Fax: +886-2-8226-7782
Email: services@tmrtek.com
www.tmrtek.com

China NEXSEC Incorporated

201, Floor 2, Unit 2, Building 15, Yard 3,
Gaolizhang Road, Haidian District,
Beijing, 100094, China
Tel: +86-10-5704-2680
Fax: +86-10-5704-2681
Email: marketing@nexsec.cn
www.nexsec.cn

NEXCOM Shanghai

Room 406-407, Building C, No 154, Lane 953,
Jianchuan Road, Minhang District,
Shanghai, 201108, China
Tel: +86-21-5278-5868
Fax: +86-21-3251-6358
Email: sales@nexcom.cn
www.nexcom.cn

NEXCOM Surveillance Technology Corp.

Floor 8, Building B3, Xiufeng Industrial Zone,
GanKeng Community, Buji Street,
LongGang District,
ShenZhen, 518112, China
Tel: +86-755-8364-7768
Fax: +86-755-8364-7738
Email: steveyang@nexcom.com.tw
www.nexcom.cn

NEXGOL Chongqing

1st Building No.999,
Star Boulevard, Yongchuan Dist,
Chongqing City, 402160, China
Tel: +86-23-4960-9080
Fax: +86-23-4966-5855
Email: sales@nexgol.com.cn
www.nexcom.cn

Beijing NexGemo Technology Co.,Ltd.

Room 205, No.1, Fazhan Road.,
Beijing International Information Industry Base,
Changping District,
Beijing, 102206, China
Tel: +86-10-8072-2025
Fax: +86-10-8072-2022
Email: sales@nexgemo.cn
www.nexgemo.cn

Japan

NEXCOM Japan

9F, Tamachi Hara Bldg.,
4-11-5, Shiba Minato-ku,
Tokyo, 108-0014, Japan
Tel: +81-3-5419-7830
Fax: +81-3-5419-7832
Email: sales@nexcom-jp.com
www.nexcom-jp.com

America

USA NEXCOM USA

46665 Fremont Blvd.,
Fremont CA 94538, USA
Tel: +1-510-656-2248
Fax: +1-510-656-2158
Email: sales@nexcom.com
www.nexcomusa.com

Package Contents

Before continuing, verify that the XPPC 22-100A package that you received is complete. Your package should have all the items listed in the following table.

Item	Part Number	Name	Description	Qty
1	10W30XPPC28X0	XPPC 22-100A System		1
2	7400090007X00	Power Adapter	90W Power Adapter	1
3	5061711844X00	Memory Sink	A JAN YU 171x60x26.2mm AL 5052 T=2.0mm	1
4	5060200715X00	Thermal Pad	T-GLOBAL 60x20x1.5mm K=3.5W/mk TG-A3500	2
5	50311F0326X00	Screw	Flat Head Screw Long FEI: F3x5 NYLOK NI+Heat Treatment F3x5 NYLOK NI+Heat Treatment	2
6	6012200052X00	Zipper Bag	PE Zipper Bag #8 炎洲:印刷由任袋8 170x240mm,W/China RoHS Symbol	1

Optional Accessories 1

Item	Part Number	Name	Description	Qty
1	5061711301X00	Panel Mount Bracket	Panel Mount BKT for XPPC 24-100 Sin Super Circle 30x20x6mm SECC T=1.6mm	14
2	6012200030X00	Bubble Wrap	Double Layers Antistaic Air Bag 鴻瑞 11x(19+24)CM	1

Optional Accessories 2

Item	Part Number	Name	Description	Qty
1	5040420229X00	Open Frame Bracket	(N)Open Frame Bracket For XPPC 22-100 Ver:A SHYUNG SHUHN 270x41.80x21.45mm SPCC NI	2
2	50311F0326X00	Screw	Flat Head Screw Long Fei: F3x5 Nylok NI+Heat Treatment F3x5 Nylok NI+Heat Treatment	8
3	6012200053X00	Zipper Bag	PE Zipper Bag #3 炎洲:印刷由任袋3號 100x70mm,W/China RoHS Symbol	1
4	6012200188X00	Bubble Wrap	Antistaic Air Bag For Chimera 15P6 Ver:A FULPAK (330+330)x450mm Color:Red	1

Ordering Information

The following below provides ordering information for XPPC 22-100A.

XPPC 22-100A (P/N: 10W30XPPC28X0)

21.5" FHD multi touchscreen computer, Intel® Celeron® J3455 w/air bonding

Panel Mount Kit (P/N: 88W30XPPC07X0)

Open Frame Kit (P/N: 88W30XPPC08X0)

CHAPTER 1: PRODUCT INTRODUCTION

XPPC 22-100A

Overview

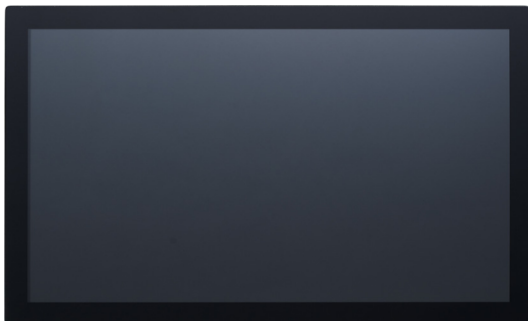

Key Features

- 21.5" TFT FHD 16:9 panel
- 10 Points P-Cap multi-touch with slim bezel design
- IP65 protection on the front
- Support: VESA/Panel/Openframe Mount
- Intel® Celeron® processor J3455, Quad Core, 1.50 GHz
- 1 x DDR3L up to 8GB, M.2 2242 Key M for storage device
- Support power input 19 VDC

Hardware Specifications

Panel

- LCD size: Innolux G-series 21.5", 16:9
- Resolution: Full HD 1920 x 1080
- Luminance
 - LCD panel: 400 cd/m²
 - XPPC PCAP touch: 85% of panel's luminance after air bonding
- Contrast ratio: 1000
- LCD color: 16.7M
- Viewing angle: 89 (U), 89 (D), 89 (L), 89 (R)

Touch Screen

- 10 points P-Cap (projected capacitive touch)
- Glass surface treatment: AS + AG

System

- CPU: onboard Intel® Celeron® processor J3455, 1.50GHz, 2M cache
- Graphic: Intel® HD graphics

Main Memory

- 1 x SO-DIMM socket support up to 8GB DDR3L 1600 MHz, non-ECC and un-buffered memory

Storage Device

- 1 x M.2 M key 2242 SSD (support SATA 3.0)

Expansion

- 1 x mini-PCIe full-size connector with SIM slot (full-size) onboard, support Wi-Fi/LTE module

Rear I/O

- 1 x COM1: RS232/422/485
- 1 x 19V DC-in power jack lock type
- 2 x RJ45 with LEDs for Gigabit LAN
- 1 x HDMI 2.0, resolution 4096 x 2160 60Hz
- 2 x USB 3.0
- 1 x Line-out
- LED for power on/off
- Power switch

Front I/O

- 2 x Antenna holes

Mechanical

- Color/material: black silver/metal sheet
- Support
 - VESA mount 100mm x 100mm
 - Panel mount
 - Open frame

Environment

- Vibration
 - IEC 60068-2-64
 - 2Grms @ sine, 5~500Hz, 1hr/axis
 - 2.2Grms @ random condition, 5~500Hz, 0.5hr/axis (non-operating)
- Shock
 - IEC 60068-2-27
 - 50g peak acceleration (11 msec. duration)

- Temperature
 - Operating temperature: with 0.7 m/s air flow: 0°C~50°C
 - Storage temperature: -20°C~60°C
- Operating humidity: 10%~90% relative humidity, non-condensing limits to be at 90%

Dimensions

- System: 520.6mm x 315.6mm x 54mm
- System weight: 5.0kg
- Package: 650mm x 480mm x 170mm
- Package weight: 7.5kg

Power Supply

- 1 x 90W AC/DC lockable adapter included in accessory
- Input: 100VAC to 240VAC
- Output: DC+19VD

Certification

- CE (EN55035 + EN55032)
- FCC Class A (EMI part 15B)
- LVD (EN62368-1)

Operating System Support

- Windows 10 64-bit
- Linux

Knowing Your XPPC 22-100A

Rear Top

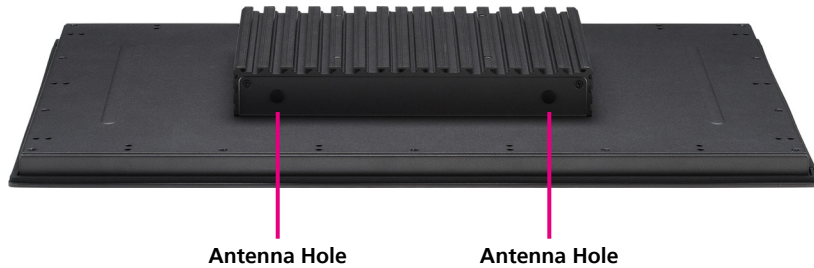

Antenna Hole

Antenna Hole

Rear Bottom

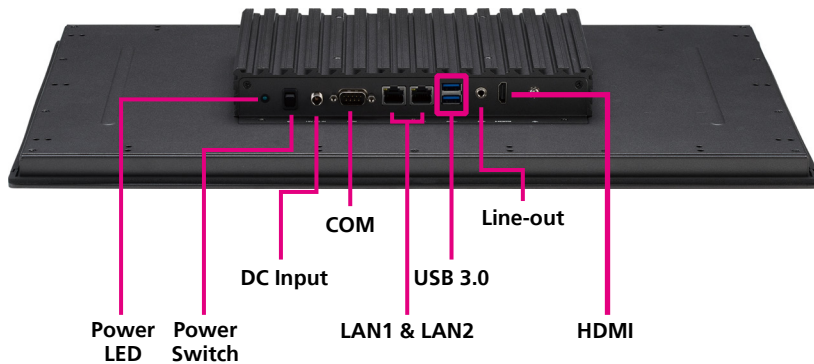
Power LED
Power Switch

DC Input

COM

LAN1 & LAN2

USB 3.0

Line-out

HDMI

Antenna Holes

The external antenna mounting holes are used to mount and connect optional Wi-Fi antennas.

Power LED

Used to indicate the power status of the system.

Power Switch

Press to power-on or power-off the system.

19V DC Input

Used to plug a DC power cord.

COM

DB9 port used to connect RS232/422/485 compatible devices.

LAN1 & LAN2 (RJ45 with LEDs)

Used to connect the system to a local area network.

USB 3.0

Used to connect USB 3.0/2.0 devices.

Line-out

Used to connect a headphone or a speaker.

HDMI

Used to connect an HDMI interface monitor.

Mechanical Dimensions

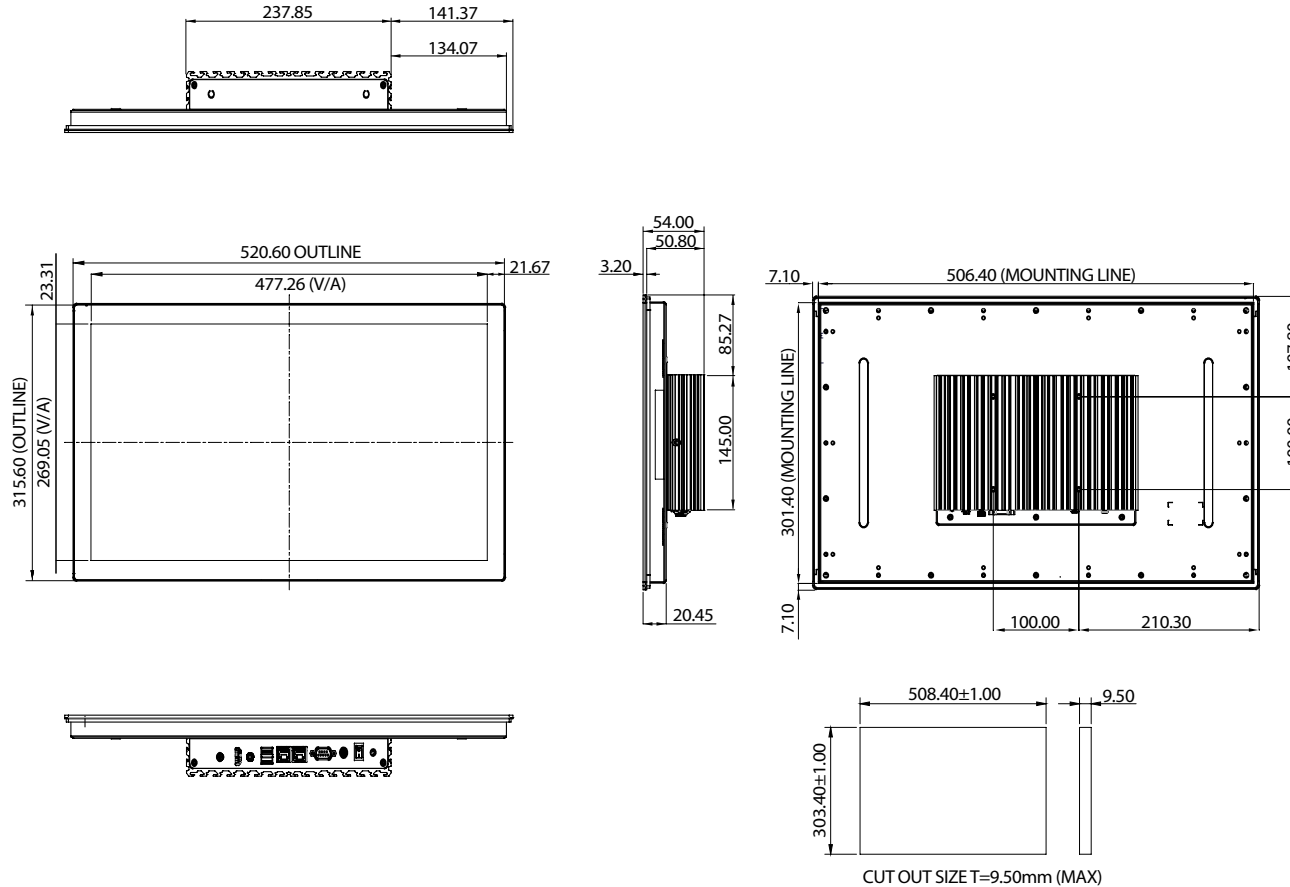

CHAPTER 2: JUMPERS AND CONNECTORS

This chapter describes how to set the jumpers and connectors on the XPPC 22-100A motherboard.

Before You Begin

- Ensure you have a stable, clean working environment. Dust and dirt can get into components and cause a malfunction. Use containers to keep small components separated.
- Adequate lighting and proper tools can prevent you from accidentally damaging the internal components. Most of the procedures that follow require only a few simple tools, including the following:
 - A Philips screwdriver
 - A flat-tipped screwdriver
 - A set of jewelers screwdrivers
 - A grounding strap
 - An anti-static pad
- Using your fingers can disconnect most of the connections. It is recommended that you do not use needle-nosed pliers to disconnect connections as these can damage the soft metal or plastic parts of the connectors.
- Before working on internal components, make sure that the power is off. Ground yourself before touching any internal components, by touching a metal object. Static electricity can damage many of the electronic components. Humid environments tend to have less static electricity than

dry environments. A grounding strap is warranted whenever danger of static electricity exists.

Precautions

Computer components and electronic circuit boards can be damaged by discharges of static electricity. Working on computers that are still connected to a power supply can be extremely dangerous.

Follow the guidelines below to avoid damage to your computer or yourself:

- Always disconnect the unit from the power outlet whenever you are working inside the case.
- If possible, wear a grounded wrist strap when you are working inside the computer case. Alternatively, discharge any static electricity by touching the bare metal chassis of the unit case, or the bare metal body of any other grounded appliance.
- Hold electronic circuit boards by the edges only. Do not touch the components on the board unless it is necessary to do so. Don't flex or stress the circuit board.
- Leave all components inside the static-proof packaging that they shipped with until they are ready for installation.
- Use correct screws and do not over tighten screws.

Jumper Settings

A jumper is the simplest kind of electric switch. It consists of two metal pins and a cap. When setting the jumpers, ensure that the jumper caps are placed on the correct pins. When the jumper cap is placed on both pins, the jumper is short. If you remove the jumper cap, or place the jumper cap on just one pin, the jumper is open.

Refer to the illustrations below for examples of what the 2-pin and 3-pin jumpers look like when they are short (on) and open (off).

Two-Pin Jumpers: Open (Left) and Short (Right)

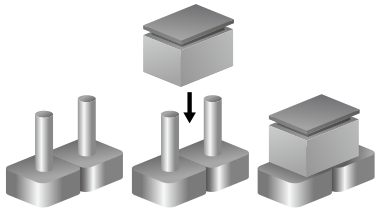

Three-Pin Jumpers: Pins 1 and 2 are Short

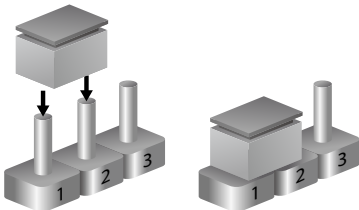

Locations of the Jumpers and Connectors for XPPC 22-100A

The figure below is the top and bottom view of the mainboard used in XPPC 22-100A. It shows the locations of the jumpers and connectors.

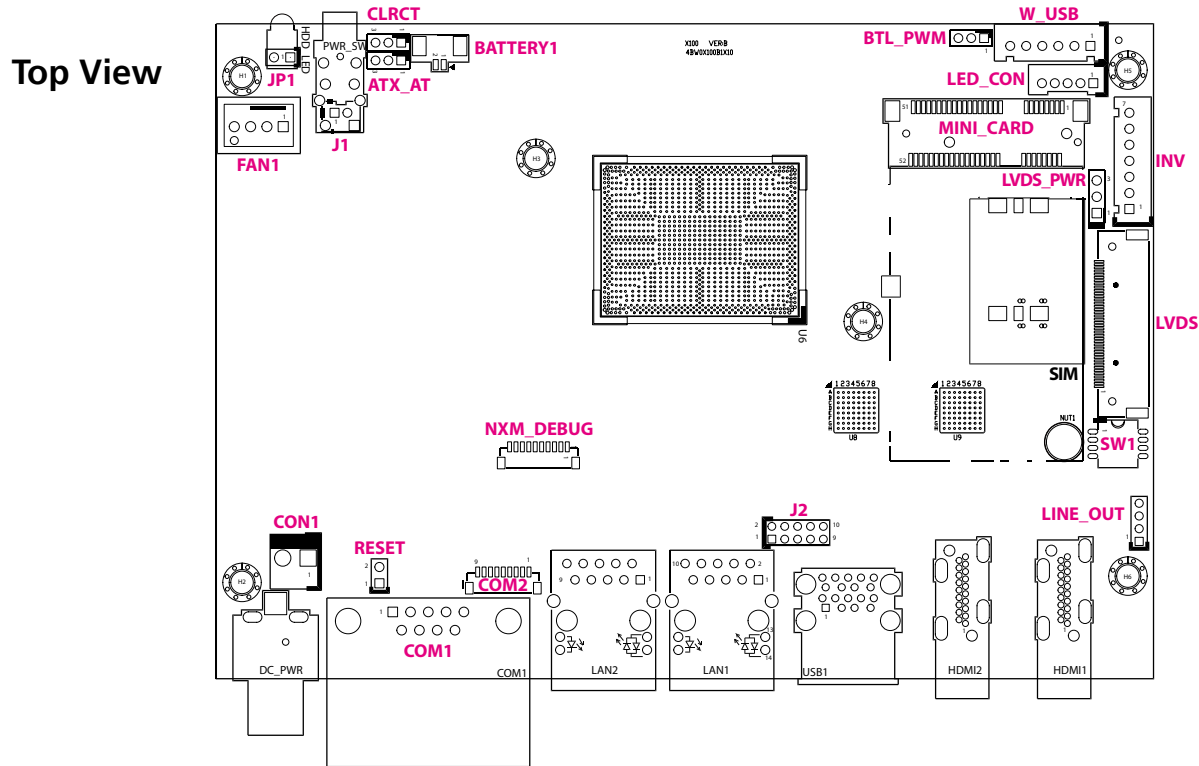

Bottom View

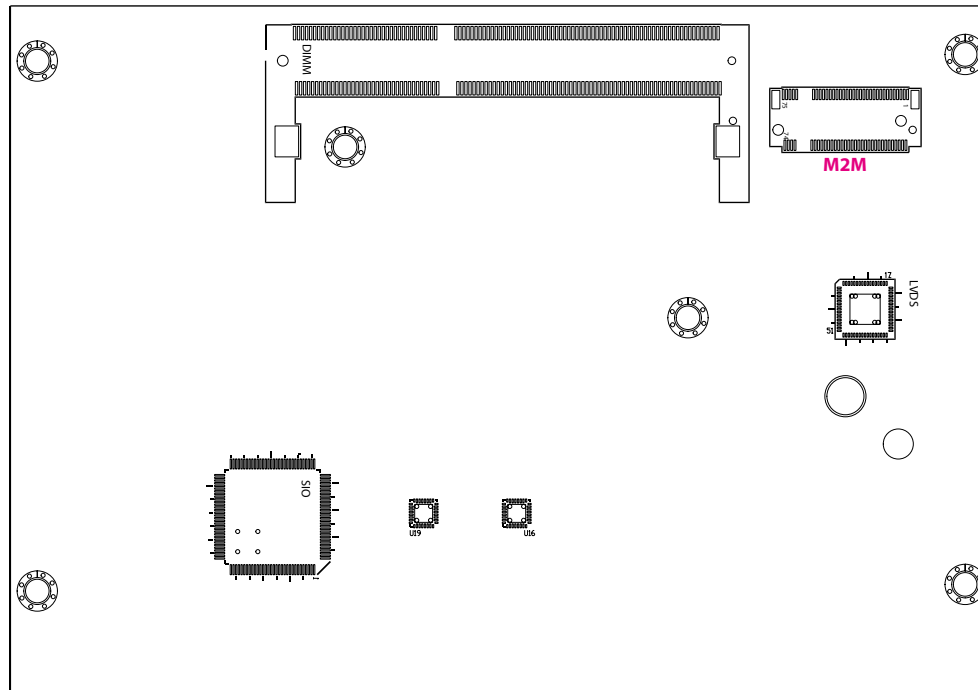

Jumpers & DIP Switches

AT/ATX Mode Select

Connector type: 1x3 3-pin header, 2.0mm pitch
Connector location: ATX_AT



Pin	Settings
1-2 On	ATX Mode
2-3 On	AT Mode

1-2 On: default

Clear CMOS

Connector type: 1x3 3-pin header, 2.0mm pitch
Connector location: CLRTC

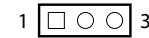

Pin	Settings
1-2 On	Normal
2-3 On	Clear CMOS

1-2 On: default

LVDS Panel Voltage Select

Connector type: 1x3 3-pin header, 2.54mm pitch

Connector location: LVDS_PWR

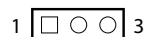

Pin	Settings
1-2 On	3.3V
2-3 On	5V

1-2 On: default

Backlight Control Voltage Select (Dimming)

Connector type: 1x3 3-pin header, 2.0mm pitch

Connector location: BLT_PWM



Pin	Settings
1-2 On	3.3V
2-3 On	5V

2-3 On: default

LVDS Resolution Select

Connector type: 4-pin DIP switch

Connector location: SW1

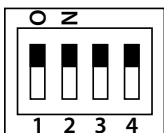

SW [3:0]	SW1 [3]	SW1 [2]	SW1 [1]	SW1 [0]	Function
0000	ON	ON	ON	ON	800 x 600 6-bit Single Port
0001	ON	ON	ON	OFF	1024 x 768 6-bit Single Port
0010	ON	ON	OFF	ON	1024 x 768 8-bit Single Port
0011	ON	ON	OFF	OFF	1280 x 1024 6-bit Single Port
0100	ON	OFF	ON	ON	1280 x 800 6-bit Single Port
0101	ON	OFF	ON	OFF	1280 x 800 8-bit Single Port
0110	ON	OFF	OFF	ON	1280 x 1024 8-bit Dual Port
0111	ON	OFF	OFF	OFF	1366 x 768 6-bit Single Port
1000	OFF	ON	ON	ON	1366 x 768 8-bit Single Port
1001	OFF	ON	ON	OFF	1440 x 900 8-bit Dual Port
1010	OFF	ON	OFF	ON	1400 x 1050 8-bit Dual Port
1011	OFF	ON	OFF	OFF	1600 x 900 8-bit Dual Port
1100	OFF	OFF	ON	ON	1680 x 1050 8-bit Dual Port
1101	OFF	OFF	ON	OFF	1600 x 1200 8-bit Dual Port
1110	OFF	OFF	OFF	ON	1920 x 1080 8-bit Dual Port
1111	OFF	OFF	OFF	OFF	1920 x 1200 8-bit Dual Port

Connector Pin Definitions

External Connector

COM1 DB9 Male Connector

Connector type: DB-9 port, 9-pin D-Sub

Connector location: COM1

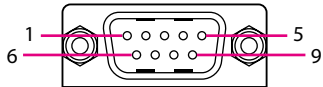

RS232		RS422		RS485	
Pin	Definition	Pin	Definition	Pin	Definition
1	DCD	1	TX-	1	TR-
2	RXD	2	TX+	2	TR+
3	TXD	3	RX+	3	
4	DTR	4	RX-	4	
5	GND	5		5	
6	DSR	6		6	
7	RTS	7		7	
8	CTS	8		8	
9	RI	9		9	

Internal Connectors

LVDS Inverter Connector

Connector type: 1x7 7-pin header JST, 2.5mm pitch

Connector location: INV

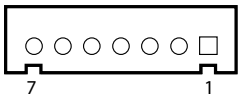

Pin	Definition	Pin	Definition
1	5V	2	12V
3	12V	4	Backlight Control
5	GND	6	GND
7	Backlight Enable		

System Reset Header

Connector type: 1x2 2-pin header, 2.54mm pitch

Connector location: RESET



Pin	Definition
1	RESET#
2	GND

LED Connector

Connector type: 1x5 5-pin header JST, 2.0mm pitch

Connector location: LED_CON

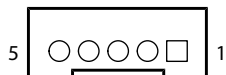

Pin	Definition	Pin	Definition
1	HDD_LED-	2	HDD_LED+
3	GND	4	Standby LED
5	PWR LED		

HDD LED Connector

Connector type: 1x2 2-pin header, 2.54mm pitch

Connector location: JP1



Pin	Definition
1	HDD_LED+
2	HDD_LED-

Line-out Connector

Connector type: 1x4 4-pin header, 2.0mm pitch

Connector location: LINE_OUT

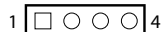

Pin	Definition	Pin	Definition
1	LOUT_L	2	GND
3	LOUT_JD	4	LOUT_R

USB Connector

Connector type: 2x5 10-pin header

Connector location: J2

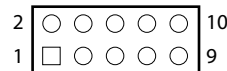

Pin	Definition	Pin	Definition
1	+5V_USB2_P45	2	GND
3	S_USB2DN4	4	GND
5	S_USB2DP4	6	S_USB2DP5
7	GND	8	S_USB2DN5
9	GND	10	+5V_USB2_P45

USB Touch

Connector type: 1x6 6-pin header JST, 2.5mm pitch
Connector location: W_USB

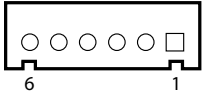

Pin	Definition	Pin	Definition
1	+5V_USB2_P2	2	S_USB2DN2
3	S_USB2DP2	4	S_USB2DN6
5	S_USB2DP6	6	GND

System Power Button Header

Connector type: 1x2 2-pin header JST, 2.0mm pitch
Connector location: J1

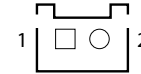

Pin	Definition
1	GND
2	PWRBTN#

DC Power Input

Connector type: 1x2 2-pin header, 3.96mm pitch

Connector location: CON1

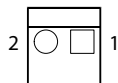

Pin	Definition
1	GND
2	+DC_IN

FAN Connector

Connector type: 1x4 4-pin header, 2.54mm pitch

Connector location: FAN1

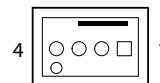

Pin	Definition	Pin	Definition
1	GND	2	+12V
3	FAN SPEED DETECT	4	FAN SPEED CONTROL

Debug Port/LPC Bus Connector

Connector type: 1x10 10-pin header, 1.0mm pitch

Connector location: NXM_DEBUG



Pin	Definition	Pin	Definition
1	+3V	2	SERIRQ
3	LAD0	4	LAD1
5	LAD2	6	LAD3
7	LFRAME#	8	25MHZ
9	PLTRST#	10	GND

COM Port Connector

Connector type: 1x9 9-pin header, 1.0mm pitch

Connector location: COM2

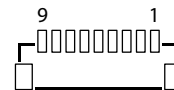

Pin	Definition	Pin	Definition
1	DCD	2	RXD
3	TXD	4	DTR
5	GND	6	DSR
7	RTS	8	CTS
9	RI		

Battery Connector

Connector type: 1x2 2-pin header, 1.25mm pitch

Connector location: BATTERY1

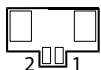

Pin	Definition
1	BAT
2	GND

LVDS Panel Connector

Connector type: 1x40 40-pin header, 0.5mm pitch

Connector location: LVDS

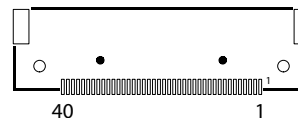

Pin	Definition	Pin	Definition
1	LVDS0_D3+	2	LVDS0_D3-
3	LVDS0_D2+	4	LVDS0_D2-
5	LVDS0_D1+	6	LVDS0_D1-
7	LVDS0_D0+	8	LVDS0_D0-
9	LVDS1_D3+	10	LVDS1_D3-
11	LVDS1_D2+	12	LVDS1_D2-
13	LVDS1_D1+	14	LVDS1_D1-
15	LVDS1_D0+	16	LVDS1_D0-
17	GND	18	+V_PANEL (3.3V or 5V)
19	+V_PANEL (3.3V or 5V)	20	+V_PANEL (3.3V or 5V)
21	GND	22	3.3V
23	GND	24	GND
25	GND	26	LVDS0_CLK+
27	LVDS0_CLK-	28	GND
29	GND	30	GND
31	SMBUS_CLK	32	Backlight Enable
33	Backlight Control	34	LVDS1_CLK+
35	LVDS1_CLK-	36	+12V
37	+12V	38	+12V
39	NC	40	SMBUS_DAT

Mini-PCIe Connector

Connector location: MINI_CARD

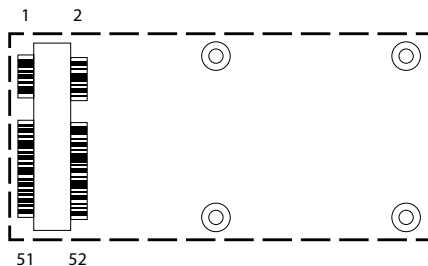

Pin	Definition	Pin	Definition
1	WAKE#	2	+3VSB
3	NC	4	GND
5	NC	6	+1.5V
7	NC	8	SIM_PWR
9	GND	10	SIM_DATA
11	REFCLK-	12	SIM_CLK
13	REFCLK+	14	SIM_RESET
15	GND	16	SIM_VPP
17	NC	18	GND
19	NC	20	WLAN_DISABLE#
21	GND	22	RESET#
23	PERn0	24	+3VSB
25	PERp0	26	GND

Pin	Definition	Pin	Definition
27	GND	28	+1.5V
29	GND	30	SMB_CLK
31	PETn0	32	SMB_DATA
33	PETp0	34	GND
35	GND	36	USB_D-
37	GND	38	USB_D+
39	+3VSB	40	GND
41	+3VSB	42	NC
43	GND	44	NC
45	NC	46	NC
47	NC	48	+1.5V
49	NC	50	GND
51	NC	52	+3VSB

M.2 Connector (M-Key)

Connector location: M2M

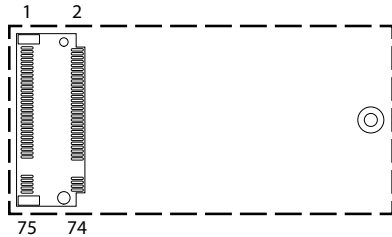

Pin	Definition	Pin	Definition
1	GND	2	+3VSB
3	GND	4	+3VSB
5	NC	6	NC
7	NC	8	NC
9	GND	10	M2M_LED#
11	NC	12	+3VSB
13	NC	14	+3VSB
15	GND	16	+3VSB
17	NC	18	+3VSB
19	NC	20	NC
21	GND	22	NC
23	NC	24	NC
25	NC	26	NC
27	GND	28	NC
29	NC	30	NC
31	NC	32	NC
33	GND	34	NC
35	NC	36	NC
37	NC	38	DEVSLP

Pin	Definition	Pin	Definition
39	GND	40	NC
41	SATA_RXP	42	NC
43	SATA_RXN	44	NC
45	GND	46	NC
47	SATA_TXN	48	NC
49	SATA_TXP	50	RESET#
51	GND	52	NC
53	NC	54	NC
55	NC	56	NC
57	GND	58	NC
67	NC	68	NC
69	NC	70	+3VSB
71	GND	72	+3VSB
73	GND	74	+3VSB
75	GND		

CHAPTER 3: SYSTEM SETUP

Removing the Top Cover from the Chassis

- Remove the 7 screws from the top cover, then lift up the system chassis box to access the mainboard.

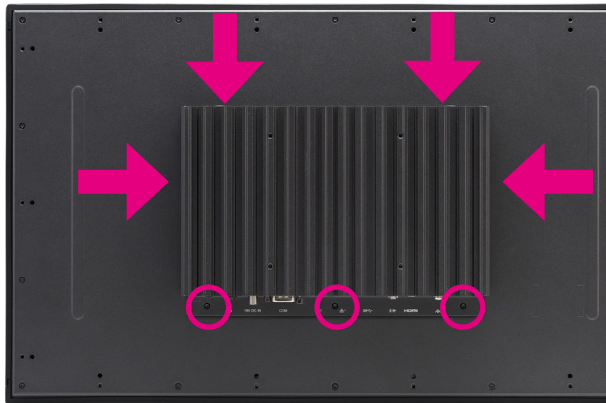

Installing DDR, SSD

- With the top cover removed, install DDR, SSD.

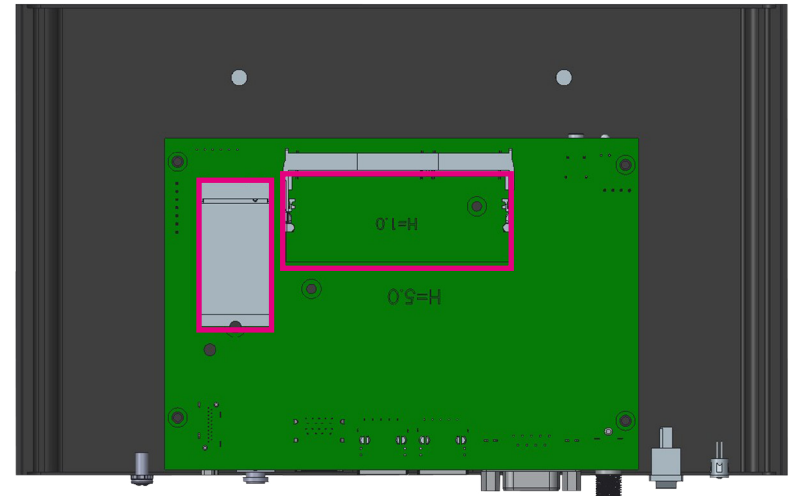

Prior to removing the top cover, make sure the unit's power is off and disconnected from the power sources to prevent electric shock or system damage.

2. Attach the thermal pads to the memory sink. You may refer to the chapter of [Preface](#) for more detailed accessories.

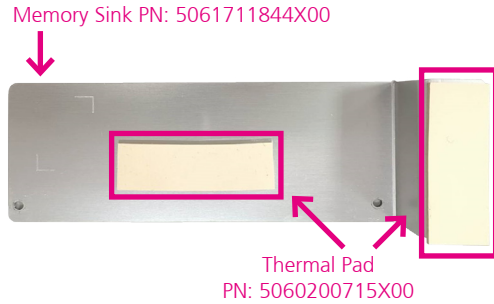

3. Once the thermal pads have been stuck to the memory sink, screw the memory sink into the motherboard's screw holes.



Installing a WiFi or LTE Module

1. Remove the 6 screws on the board and IO bracket. Next, remove the board from the chassis.

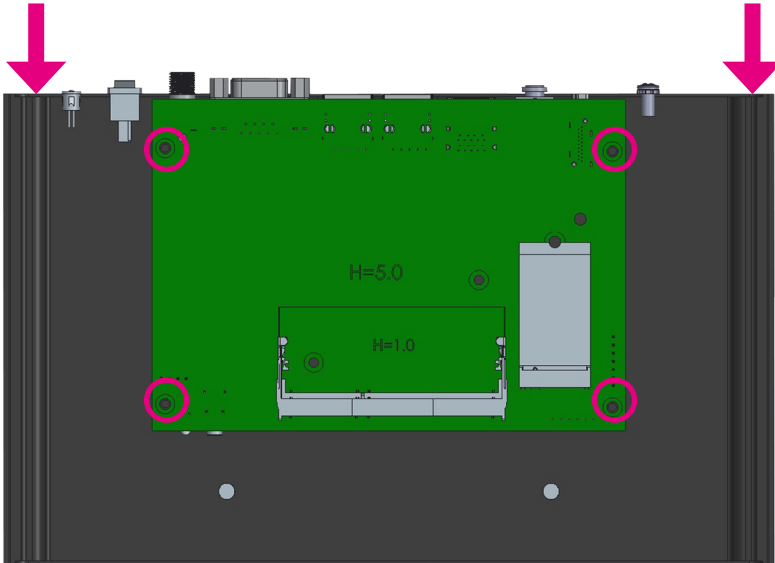

2. Locate the WiFi or LTE module.

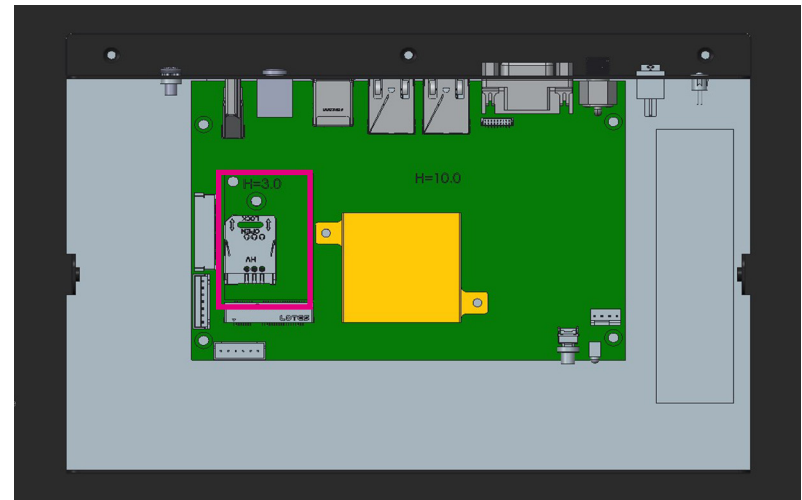

Installing VESA Mount Kit

1. Align the mounting holes on the VESA mount bracket to the VESA mounting holes on the back of the panel PC, then secure the VESA mount bracket with screws.



Recommended screws for the VESA mount kit:
4 * M4x8 screws.

Installing Open Frame Kit

1. Turn to the rear side of the panel PC and align the mounting holes on the open frame bracket to the open frame mounting holes on the panel PC, then secure the open frame bracket with screws.

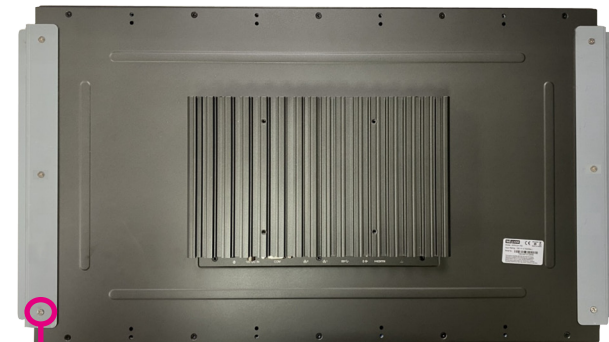

6 * Screws (F3x5 Nylok NI+Heat)

System Dimensions with Open Frame Kit

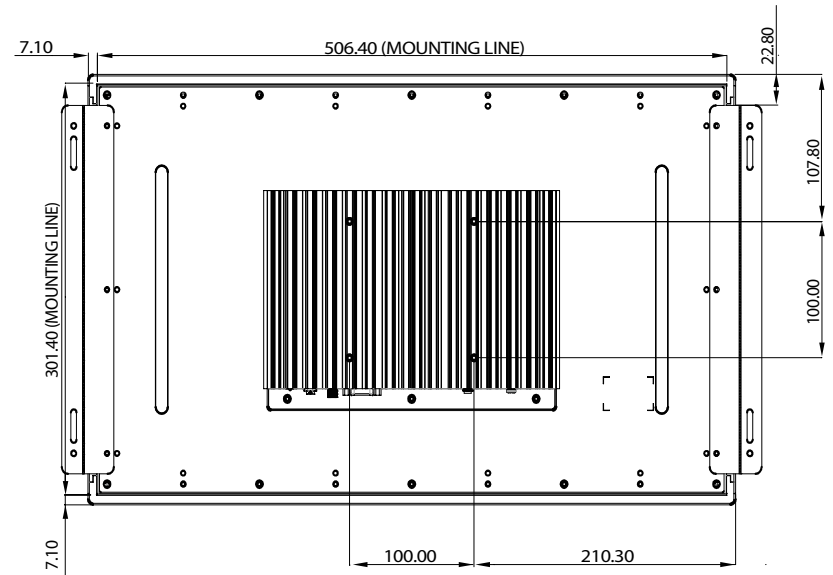
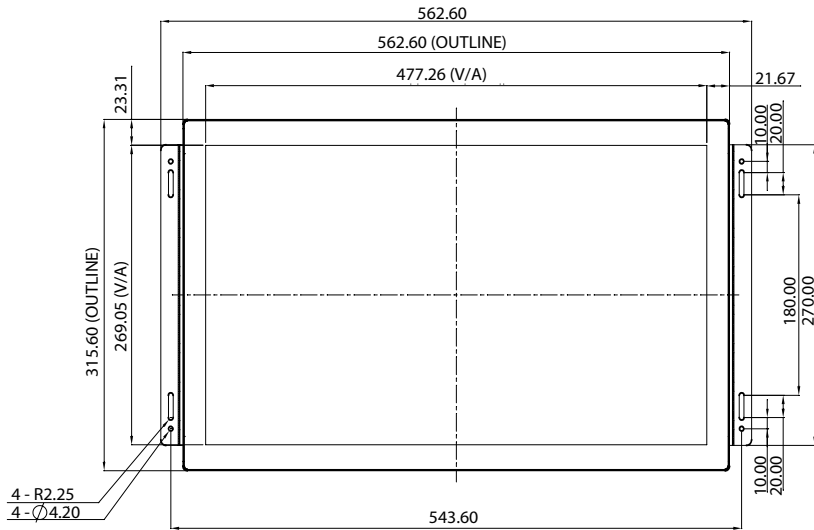

Panel Mounting

1. Select a place on the panel where you will mount the panel PC.
2. Cut out a shape on the panel that corresponds to the panel PC's rear dimensions.

The thickness of the panel (e.g. steel board, plank, acrylic board, wall, etc.) where you will mount the panel PC must not exceed 9.5mm. If the distance between the front bezel and panel mount hole is too wide, it will not fit the panel mount kit.

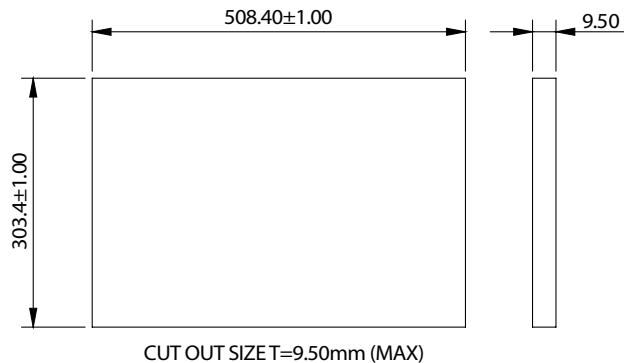

3. Slide the panel PC through the hole until it is properly fitted against the panel.

4. Position the mounting clamps along the rear edges of the panel PC. The first and second clamps must be positioned and secured diagonally prior to mounting the rest of the clamps.

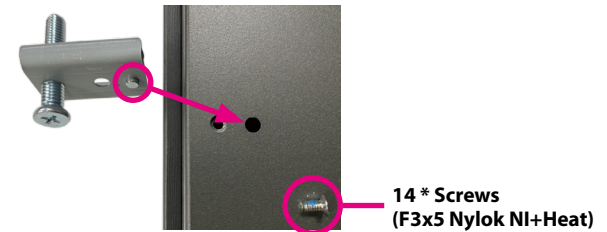

5. Tighten the clamp's screw until it touches the panel.

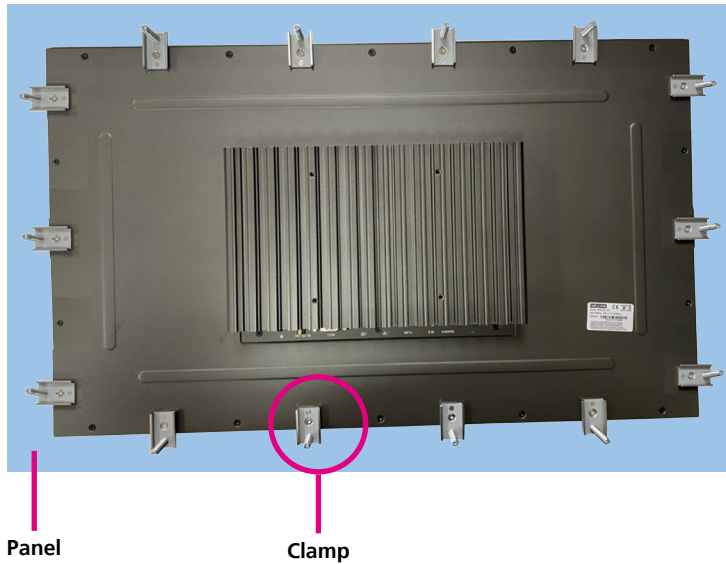

Do not overtighten the screws to prevent damaging the Panel PC.

CHAPTER 4: BIOS SETUP

This chapter describes how to use the BIOS setup program for XPPC 22-100A. The BIOS screens provided in this chapter are for reference only and may change if the BIOS is updated in the future.

To check for the latest updates and revisions, visit the NEXCOM website at www.nexcom.com.tw.

About BIOS Setup

The BIOS (Basic Input and Output System) Setup program is a menu driven utility that enables you to make changes to the system configuration and tailor your system to suit your individual work needs. It is a ROM-based configuration utility that displays the system's configuration status and provides you with a tool to set system parameters.

These parameters are stored in non-volatile battery-backed-up CMOS RAM that saves this information even when the power is turned off. When the system is turned back on, the system is configured with the values found in CMOS.

With easy-to-use pull down menus, you can configure such items as:

- Hard drives, diskette drives, and peripherals
- Video display type and display options
- Password protection from unauthorized use
- Power management features

The settings made in the setup program affect how the computer performs. It is important, therefore, first to try to understand all the setup options, and second, to make settings appropriate for the way you use the computer.

When to Configure the BIOS

- This program should be executed under the following conditions:
 - When changing the system configuration
 - When a configuration error is detected by the system and you are prompted to make changes to the setup program
 - When resetting the system clock
 - When redefining the communication ports to prevent any conflicts
 - When making changes to the Power Management configuration
 - When changing the password or making other changes to the security setup

Normally, CMOS setup is needed when the system hardware is not consistent with the information contained in the CMOS RAM, whenever the CMOS RAM has lost power, or the system features need to be changed.

Default Configuration

Most of the configuration settings are either predefined according to the Load Optimal Defaults settings which are stored in the BIOS or are automatically detected and configured without requiring any actions. There are a few settings that you may need to change depending on your system configuration.

Entering Setup











When the system is powered on, the BIOS will enter the Power-On Self Test (POST) routines. These routines perform various diagnostic checks; if an error is encountered, the error will be reported in one of two different ways:

- If the error occurs before the display device is initialized, a series of beeps will be transmitted.
- If the error occurs after the display device is initialized, the screen will display the error message.

Powering on the computer and immediately pressing allows you to enter Setup.

Press the  key to enter Setup:

Legends

Key	Function
	Moves the highlight left or right to select a menu.
	Moves the highlight up or down between sub-menus or fields.
	Exits the BIOS Setup Utility.
	Scrolls forward through the values or options of the highlighted field.
	Scrolls backward through the values or options of the highlighted field.
	Selects a field.
	Displays General Help.
	Load previous values.
	Load optimized default values.
	Saves and exits the Setup program.
	Press <Enter> to enter the highlighted sub-menu

Scroll Bar

When a scroll bar appears to the right of the setup screen, it indicates that there are more available fields not shown on the screen. Use the up and down arrow keys to scroll through all the available fields.

Submenu

When “▶” appears on the left of a particular field, it indicates that a submenu which contains additional options are available for that field. To display the submenu, move the highlight to that field and press  .

BIOS Setup Utility

Once you enter the AMI BIOS Setup Utility, the Main Menu will appear on the screen. The main menu allows you to select from several setup functions and one exit. Use arrow keys to select among the items and press  to accept or enter the submenu.

Main

The Main menu is the first screen that you will see when you enter the BIOS Setup Utility.

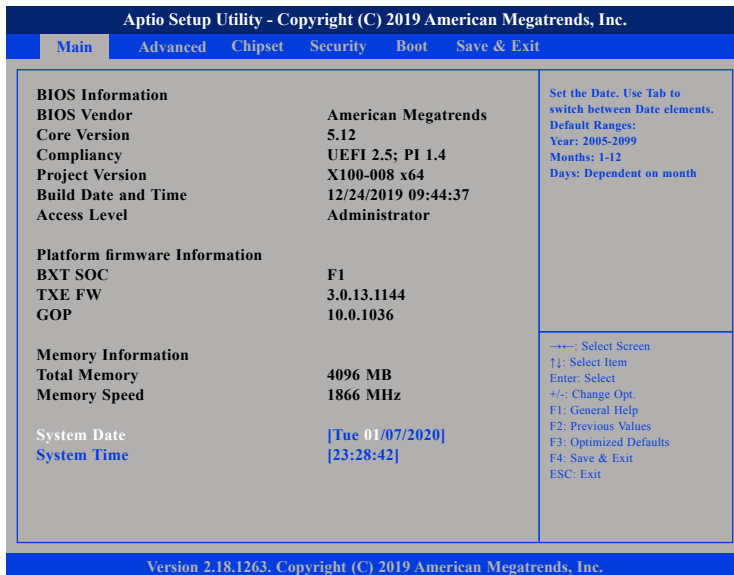

Aptio Setup Utility - Copyright (C) 2019 American Megatrends, Inc.		
Main Advanced Chipset Security Boot Save & Exit		
BIOS Information		Set the Date. Use Tab to switch between Date elements.
BIOS Vendor	American Megatrends	Default Ranges:
Core Version	5.12	Year: 2005-2099
Compliance	UEFI 2.5; PI 1.4	Months: 1-12
Project Version	X100-008 x64	Days: Dependent on month
Build Date and Time	12/24/2019 09:44:37	
Access Level	Administrator	
Platform firmware Information		
BXT SOC	F1	
TXE FW	3.0.13.1144	
GOP	10.0.1036	
Memory Information		←→: Select Screen
Total Memory	4096 MB	↑↓: Select Item
Memory Speed	1866 MHz	Enter: Select
		+/-: Change Opt.
		F1: General Help
		F2: Previous Values
		F3: Optimized Defaults
		F4: Save & Exit
		ESC: Exit
System Date	[Tue 01/07/2020]	
System Time	[23:28:42]	
Version 2.18.1263. Copyright (C) 2019 American Megatrends, Inc.		

System Date

The date format is <day>, <month>, <date>, <year>. Day displays a day, from Monday to Sunday. Month displays the month, from January to December. Date displays the date, from 1 to 31. Year displays the year, from 2005 to 2099.

System Time

The time format is <hour>, <minute>, <second>. The time is based on the 24-hour military-time clock. For example, 1 p.m. is 13:00:00. Hour displays hours from 00 to 23. Minute displays minutes from 00 to 59. Second displays seconds from 00 to 59.

Advanced

The Advanced menu allows you to configure your system for basic operation. Some entries are defaults required by the system board, while others, if enabled, will improve the performance of your system or let you set some features according to your preference.



Setting incorrect field values may cause the system to malfunction.



Restore AC Power Loss

Configures the power state when power is re-applied after a power failure.

ACPI Settings

This section is used to configure ACPI settings.

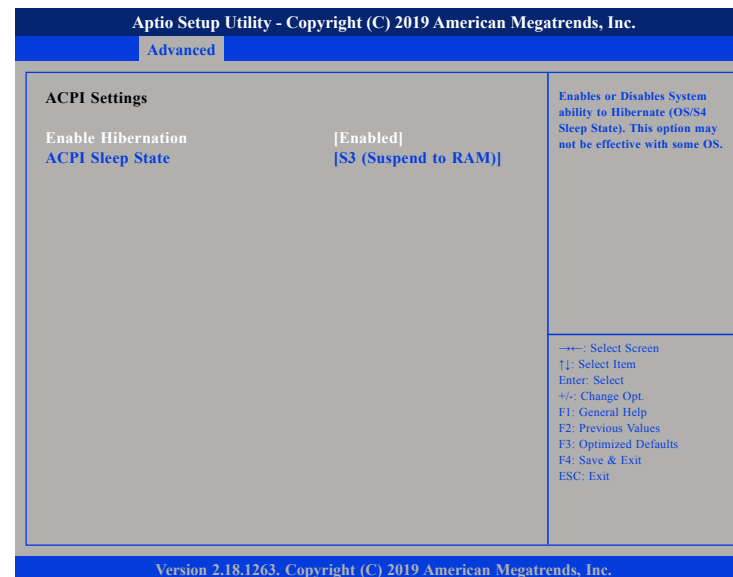

Enable Hibernation

Enables or disables system ability to hibernate (OS/S4 Sleep State). This option may not be effective with some operating systems.

ACPI Sleep State

Select the highest ACPI sleep state the system will enter when the suspend button is pressed. The options are Suspend Disabled and S3 (Suspend to RAM).

NCT6793D Super IO Configuration

This section is used to configure the serial ports.



Super IO Chip

Displays the Super I/O chip used on the board.

Serial Port 1 Configuration

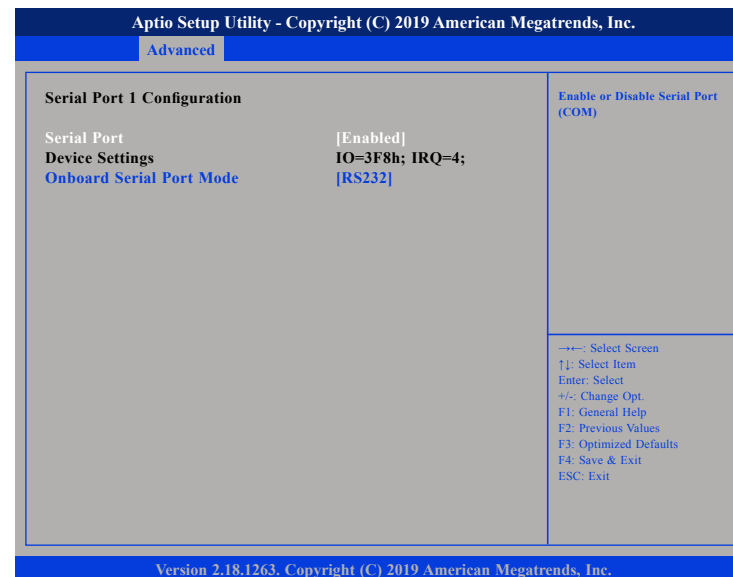

Serial Port

Enables or disables the serial COM port.

Device Settings

Displays the IO address and IRQ of the serial COM port.

Onboard Serial Port Mode

Select this to change the serial port mode to RS232, RS422, RS485 No Terminator or RS485 With Terminator.

Serial Port 2 Configuration



Serial Port

Enables or disables the serial COM port.

Device Settings

Displays the IO address and IRQ of the serial COM port.

Hardware Monitor

This section is used to monitor hardware status such as temperature, fan speed and voltages.

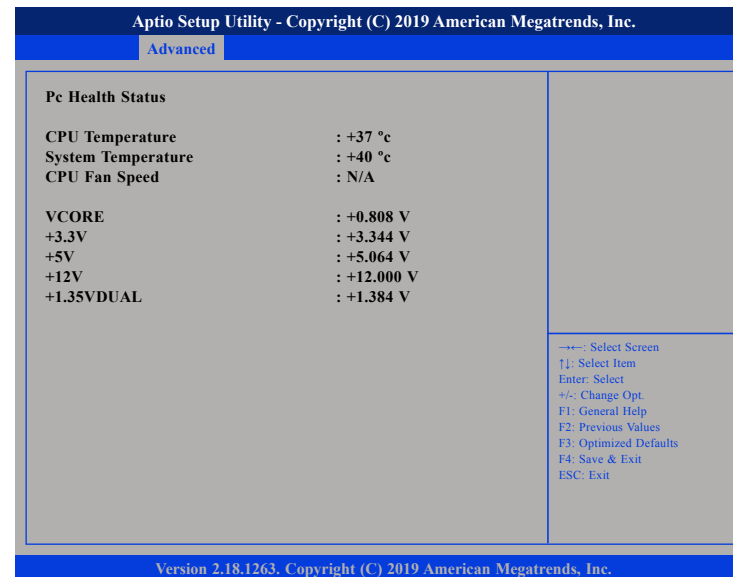

CPU Temperature

Detects and displays the current CPU temperature.

System Temperature

Detects and displays the current system temperature.

CPU Fan Speed

Detects and displays the current CPU fan speed.

VCORE to 1.35VDUAL

Detects and displays the output voltages.

S5 RTC Wake Settings

This section is used to configure the system to wake from S5 using RTC alarm.

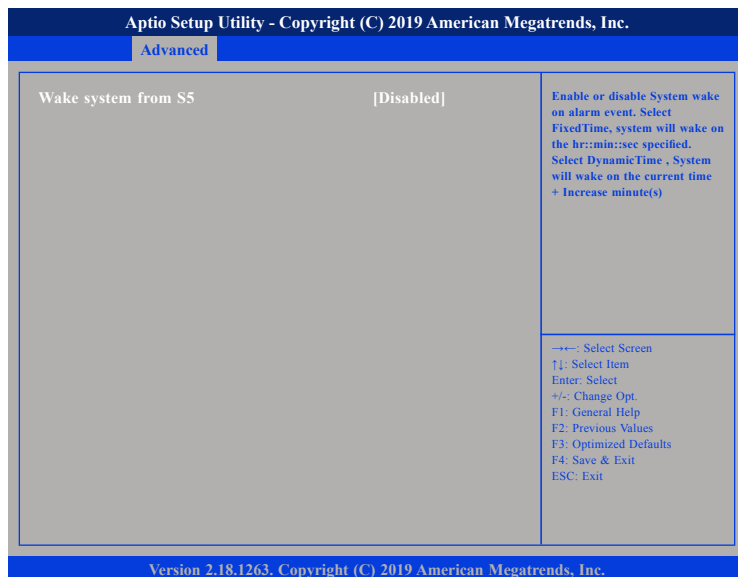

Wake system from S5

Enables or disables system wake on alarm event. When FixedTime is selected, system will wake on the hr::min::sec specified. When DynamicTime is selected, system will wake on the current time + Increase minute(s).

CPU Configuration

This section is used to view CPU status and configure CPU parameters.



Active Processor Cores

Select the number of cores to enable in each processor package.

Intel® Virtualization Technology

When this field is set to Enabled, the VMM can utilize the additional hardware capabilities provided by Vanderpool Technology.

VT-d

Enables or disables VT-d function on MCH.

Socket 0 CPU Information

Display information on the CPU installed on socket 0.

Aptio Setup Utility - Copyright (C) 2019 American Megatrends, Inc.

Advanced

Socket 0 CPU Information	
Intel(R) Celeron(R) CPU J3455E @ 1.50GHz	
CPU Signature	506CA
Microcode Patch	1A
Max CPU Speed	1500 MHz
Min CPU Speed	800 MHz
Processor Cores	4
Intel HT Technology	Not Supported
Intel VT-x Technology	Supported
L1 Data Cache	24 kB x 4
L1 Code Cache	32 kB x 4
L2 Cache	1024 kB x 2
L3 Cache	Not Present

→←: Select Screen
 ↑↓: Select Item
 Enter: Select
 +/-: Change Opt.
 F1: General Help
 F2: Previous Values
 F3: Optimized Defaults
 F4: Save & Exit
 ESC: Exit

Version 2.18.1263. Copyright (C) 2019 American Megatrends, Inc.

CPU Power Management

Aptio Setup Utility - Copyright (C) 2019 American Megatrends, Inc.

Advanced

CPU Power Management Configuration	Enable/Disable Intel SpeedStep
EIST [Disabled]	

→←: Select Screen
 ↑↓: Select Item
 Enter: Select
 +/-: Change Opt.
 F1: General Help
 F2: Previous Values
 F3: Optimized Defaults
 F4: Save & Exit
 ESC: Exit

Version 2.18.1263. Copyright (C) 2019 American Megatrends, Inc.

EIST

Enables or disables Intel® SpeedStep.

Network Stack Configuration

This section is used to configure the network stack settings.

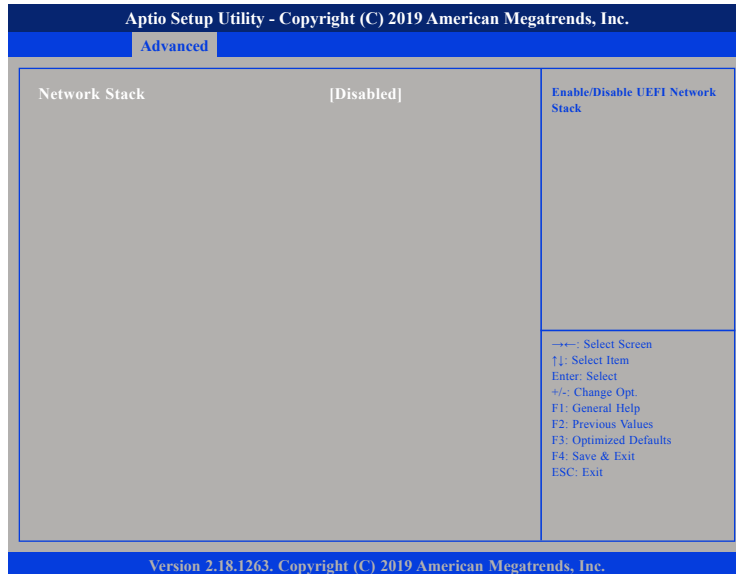

Network Stack

Enables or disables UEFI network stack.

Trusted Computing

This section is used to configure Trusted Platform Module (TPM) settings.



Security Device Support

Enables or disables BIOS support for security device. O.S will not show Security Device. TCG EFI protocol and INT1A interface will not be available.

USB Configuration

This section is used to configure the USB.

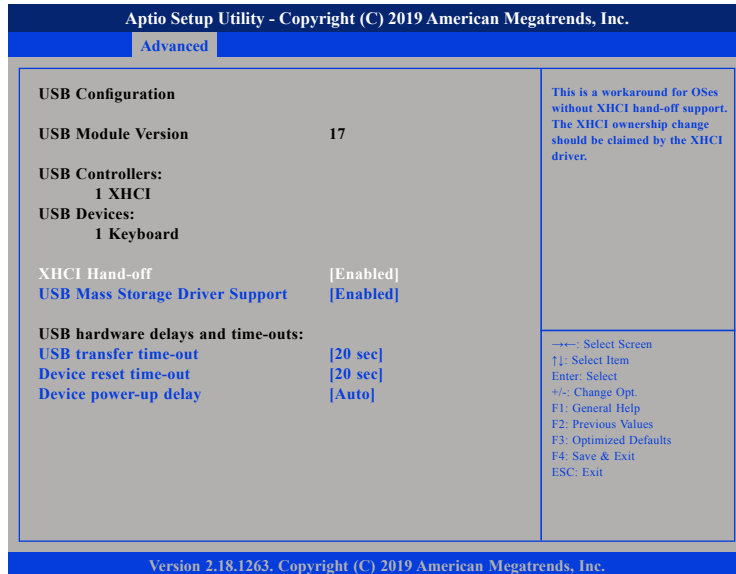

XHCI Hand-off

This is a workaround for OSs that does not support XHCI hand-off. The XHCI ownership change should be claimed by the XHCI driver.

USB Mass Storage Driver Support

Enables or disables USB mass storage driver support.

USB transfer time-out

The time-out value for control, bulk, and Interrupt transfers.

Device reset time-out

Selects the USB mass storage device's start unit command timeout.

Device power-up delay

Maximum time the value will take before it properly reports itself to the Host Controller. "Auto" uses default value: for a Root port it is 100 ms, for a Hub port the delay is taken from Hub descriptor.

Chipset

This section is used to configure the system based on the specific features of the chipset.



South Bridge

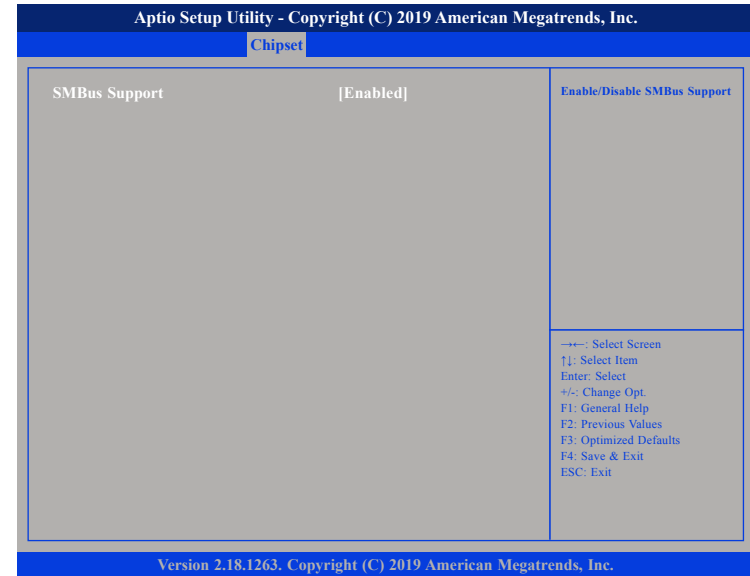

SMBus Support

Enables or disables SMBus support.



Setting incorrect field values may cause the system to malfunction.

South Cluster Configuration



HD-Audio Configuration



HD-Audio Support

Enables or disables HD Audio support.

SATA Drives

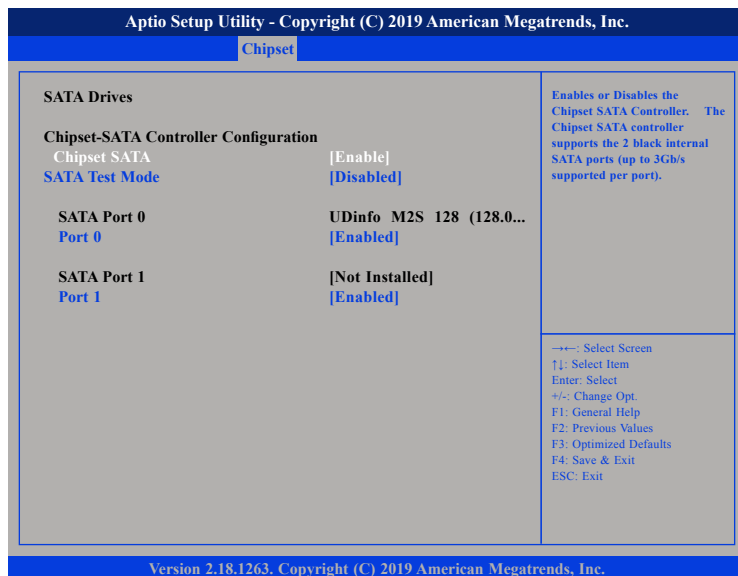

Chipset SATA

Enables or disables the SATA controller chipset. The SATA controller chipset supports the 2 black internal SATA ports (up to 3Gb/s supported per port).

SATA Test Mode

Enables or disables SATA test mode.

Port 0

Enables or disables SATA port 0.

Port 1

Enables or disables SATA port 1.

USB Configuration

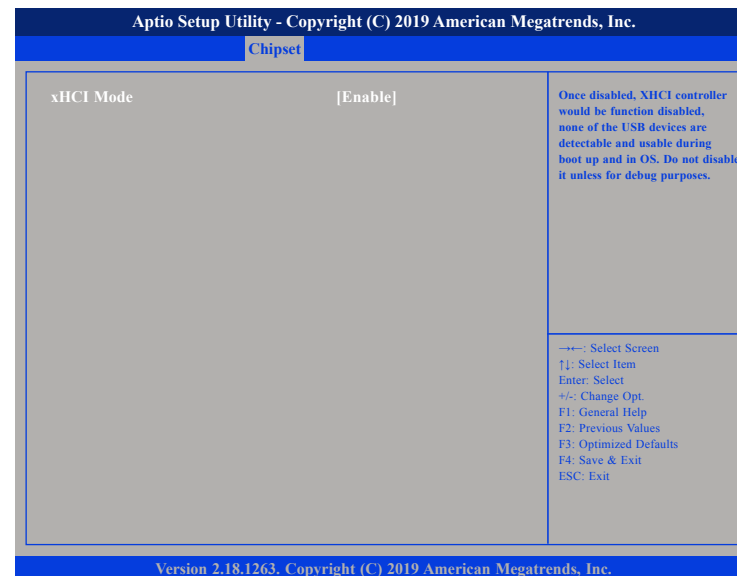

xHCI Mode

Enables or disables XHCI mode. Once disabled, XHCI controller function will be disabled and all the USB devices will not be detectable and usable during boot up and in OS. Please do not disable it unless for debugging purposes.

Miscellaneous Configuration

Aptio Setup Utility - Copyright (C) 2019 American Megatrends, Inc.	
Chipset	
Miscellaneous Configuration High Precision Timer [Enable] USB Power State in S5 [ON]	Select USB power state in S5. --- Select Screen ↑ Select Item Enter: Select +/- Change Opt. F1: General Help F2: Previous Values F3: Optimized Defaults F4: Save & Exit ESC: Exit
Version 2.18.1263. Copyright (C) 2019 American Megatrends, Inc.	

High Precision Timer

Enables or disables high precision event timer.

USB Power State in S5

Configures the USB power state in S5.

Security

Aptio Setup Utility - Copyright (C) 2019 American Megatrends, Inc.					
Main	Advanced	Chipset	Security	Boot	Save & Exit
Password Description If ONLY the Administrator's password is set, then this only limits access to Setup and is only asked for when entering Setup. If ONLY the User's password is set, then this is a power on password and must be entered to boot or enter Setup. In Setup the User Will have Administrator rights. The password length must be in the following range: Minimum length 3 Maximum length 20 Setup Administrator Password User Password	Set Setup Administrator Password --- Select Screen ↑ Select Item Enter: Select +/- Change Opt. F1: General Help F2: Previous Values F3: Optimized Defaults F4: Save & Exit ESC: Exit				
Version 2.18.1263. Copyright (C) 2019 American Megatrends, Inc.					

Setup Administrator Password

Select this to reconfigure the administrator's password.

User Password

Select this to reconfigure the user's password.

Boot



Bootup NumLock State

This allows you to determine the default state of the numeric keypad. By default, the system boots up with NumLock on wherein the function of the numeric keypad is the number keys. When set to Off, the function of the numeric keypad is the arrow keys

Quiet Boot

Enabled Displays OEM logo instead of the POST messages.
 Disabled Displays normal POST messages.

Boot Option Priorities

Adjust the boot sequence of the system. Boot Option #1 is the first boot device that the system will boot from, next will be #2 and so forth.

Fast Boot

Enables or disables boot with initialization of a minimal set of devices required to launch active boot option. Has no effect for BBS boot options.

Save & Exit



Save Changes and Reset

To save the changes and reset, select this field then press <Enter>. A dialog box will appear. Confirm by selecting Yes.

Discard Changes and Reset

To exit the Setup utility and reboot the system without saving the changes, select this field then press <Enter>. You may be prompted to confirm again before exiting.

Restore Defaults

To restore the BIOS to default settings, select this field then press <Enter>. A dialog box will appear. Confirm by selecting Yes.