



**NEXCOM International Co., Ltd.**

**Intelligent Platform & Services Business Unit**

**Wide Screen Touch Computer**

**XPPC 10-100**

User Manual

# CONTENTS

## Preface

Copyright .....	iv
Disclaimer .....	iv
Acknowledgements .....	iv
Regulatory Compliance Statements .....	iv
Declaration of Conformity .....	iv
RoHS Compliance .....	v
Warranty and RMA .....	vi
Safety Information .....	viii
Installation Recommendations .....	viii
Safety Precautions .....	ix
Technical Support and Assistance .....	x
Conventions Used in this Manual .....	x
Global Service Contact Information .....	xi
Package Contents .....	xiii
Ordering Information .....	xiv

## Chapter 1: Product Introduction

XPPC 10-100 .....	1
Overview .....	1
Key Features .....	1
Hardware Specifications .....	2
Knowing Your XPPC 10-100 .....	4
Rear Bottom .....	4
Rear Top .....	4
Mechanical Dimensions .....	5

## Chapter 2: Jumpers and Connectors

Before You Begin .....	6
Precautions .....	6
Jumper Settings .....	7
Locations of the Jumpers and Connectors for XPPC 10-100 .....	8
Top View .....	8
Bottom View .....	9
Jumpers & DIP Switches .....	10
AT/ATX Mode Select .....	10
Clear CMOS .....	10
LVDS Panel Voltage Select .....	11
Backlight Control Voltage Select (Dimming) .....	11
LVDS Resolution Select .....	12
Connector Pin Definitions .....	13
External Connector .....	13
COM1 DB9 Male Connector .....	13
Internal Connectors .....	14
LVDS Inverter Connector .....	14
System Reset Header .....	14
LED Connector .....	15
HDD LED Connector .....	15
Line-out Connector .....	16
USB Connector .....	16
USB Touch .....	17
System Power Button Header .....	17
DC Power Input .....	18



- FAN Connector ..... 18
- Debug Port/LPC Bus Connector ..... 19
- COM Port Connector ..... 19
- Battery Connector ..... 20
- LVDS Panel Connector ..... 20
- Mini-PCIe Connector ..... 21
- M.2 Connector (Key M) ..... 22

### Chapter 3: System Setup

- Removing the Top Cover from the Chassis ..... 23
- Installing Memory Module & Storage Drive ..... 23
- Installing a Wi-Fi or LTE Module (Mini-PCIe) ..... 24
- Installing VESA Mount Kit ..... 25
- Installing Open Frame Kit ..... 25
- System Dimensions with Open Frame Kit ..... 26
- Panel Mounting ..... 27

### Chapter 4: BIOS Setup

- About BIOS Setup ..... 29
- When to Configure the BIOS ..... 29
- Default Configuration ..... 30
- Entering Setup ..... 30
- Legends ..... 30
- BIOS Setup Utility ..... 32
  - Main ..... 32
  - Advanced ..... 33
  - Chipset ..... 40
  - Security ..... 43
  - Boot ..... 44
  - Save & Exit ..... 45



# PREFACE

## Copyright

This publication, including all photographs, illustrations and software, is protected under international copyright laws, with all rights reserved. No part of this manual may be reproduced, copied, translated or transmitted in any form or by any means without the prior written consent from NEXCOM International Co., Ltd.

## Disclaimer

The information in this document is subject to change without prior notice and does not represent commitment from NEXCOM International Co., Ltd. However, users may update their knowledge of any product in use by constantly checking its manual posted on our website: <http://www.nexcom.com>. NEXCOM shall not be liable for direct, indirect, special, incidental, or consequential damages arising out of the use of any product, nor for any infringements upon the rights of third parties, which may result from such use. Any implied warranties of merchantability or fitness for any particular purpose is also disclaimed.

## Acknowledgements

XPPC 10-100 is a trademark of NEXCOM International Co., Ltd. All other product names mentioned herein are registered trademarks of their respective owners.

## Regulatory Compliance Statements

This section provides the FCC compliance statement for Class A devices and describes how to keep the system CE compliant.

## Declaration of Conformity

### FCC

This equipment has been tested and verified to comply with the limits for a Class A digital device, pursuant to Part 15 of FCC Rules. These limits are designed to provide reasonable protection against harmful interference when the equipment is operated in a commercial environment. This equipment generates, uses, and can radiate radio frequency energy and, if not installed and used in accordance with the instructions, may cause harmful interference to radio communications. Operation of this equipment in a residential area (domestic environment) is likely to cause harmful interference, in which case the user will be required to correct the interference (take adequate measures) at their own expense.

### CE

The product(s) described in this manual complies with all applicable European Union (CE) directives if it has a CE marking. For computer systems to remain CE compliant, only CE-compliant parts may be used. Maintaining CE compliance also requires proper cable and cabling techniques.

## RoHS Compliance



### **NEXCOM RoHS Environmental Policy and Status Update**

NEXCOM is a global citizen for building the digital infrastructure. We are committed to providing green products and services, which are compliant with European Union RoHS (Restriction on Use of Hazardous Substance in Electronic Equipment) directive 2011/65/EU, to be your trusted green partner and to protect our environment.

RoHS restricts the use of Lead (Pb) < 0.1% or 1,000ppm, Mercury (Hg) < 0.1% or 1,000ppm, Cadmium (Cd) < 0.01% or 100ppm, Hexavalent Chromium (Cr6+) < 0.1% or 1,000ppm, Polybrominated biphenyls (PBB) < 0.1% or 1,000ppm, and Polybrominated diphenyl Ethers (PBDE) < 0.1% or 1,000ppm.

In order to meet the RoHS compliant directives, NEXCOM has established an engineering and manufacturing task force to implement the introduction of green products. The task force will ensure that we follow the standard NEXCOM development procedure and that all the new RoHS components and new manufacturing processes maintain the highest industry quality levels for which NEXCOM are renowned.

The model selection criteria will be based on market demand. Vendors and suppliers will ensure that all designed components will be RoHS compliant.

### **How to recognize NEXCOM RoHS Products?**

For existing products where there are non-RoHS and RoHS versions, the suffix "(LF)" will be added to the compliant product name.

All new product models launched after January 2013 will be RoHS compliant. They will use the usual NEXCOM naming convention.

## Warranty and RMA

### NEXCOM Warranty Period

NEXCOM manufactures products that are new or equivalent to new in accordance with industry standard. NEXCOM warrants that products will be free from defect in material and workmanship for 2 years, beginning on the date of invoice by NEXCOM.

### NEXCOM Return Merchandise Authorization (RMA)

- Customers shall enclose the “NEXCOM RMA Service Form” with the returned packages.
- Customers must collect all the information about the problems encountered and note anything abnormal or, print out any on-screen messages, and describe the problems on the “NEXCOM RMA Service Form” for the RMA number apply process.
- Customers can send back the faulty products with or without accessories (manuals, cable, etc.) and any components from the card, such as CPU and RAM. If the components were suspected as part of the problems, please note clearly which components are included. Otherwise, NEXCOM is not responsible for the devices/parts.
- Customers are responsible for the safe packaging of defective products, making sure it is durable enough to be resistant against further damage and deterioration during transportation. In case of damages occurred during transportation, the repair is treated as “Out of Warranty.”
- Any products returned by NEXCOM to other locations besides the customers’ site will bear an extra charge and will be billed to the customer.

### Repair Service Charges for Out-of-Warranty Products

NEXCOM will charge for out-of-warranty products in two categories, one is basic diagnostic fee and another is component (product) fee.

#### System Level

- Component fee: NEXCOM will only charge for main components such as SMD chip, BGA chip, etc. Passive components will be repaired for free, ex: resistor, capacitor.
- Items will be replaced with NEXCOM products if the original one cannot be repaired. Ex: motherboard, power supply, etc.
- Replace with 3rd party products if needed.
- If RMA goods can not be repaired, NEXCOM will return it to the customer without any charge.

#### Board Level

- Component fee: NEXCOM will only charge for main components, such as SMD chip, BGA chip, etc. Passive components will be repaired for free, ex: resistors, capacitors.
- If RMA goods can not be repaired, NEXCOM will return it to the customer without any charge.

## Warnings

Read and adhere to all warnings, cautions, and notices in this guide and the documentation supplied with the chassis, power supply, and accessory modules. If the instructions for the chassis and power supply are inconsistent with these instructions or the instructions for accessory modules, contact the supplier to find out how you can ensure that your computer meets safety and regulatory requirements.

## Cautions

Electrostatic discharge (ESD) can damage system components. Do the described procedures only at an ESD workstation. If no such station is available, you can provide some ESD protection by wearing an antistatic wrist strap and attaching it to a metal part of the computer chassis.

## Safety Information

Before installing and using the device, note the following precautions:

- Read all instructions carefully.
- Do not place the unit on an unstable surface, cart, or stand.
- Follow all warnings and cautions in this manual.
- When replacing parts, ensure that your service technician uses parts specified by the manufacturer.
- Avoid using the system near water, in direct sunlight, or near a heating device.
- The load of the system unit does not solely rely for support from the rackmounts located on the sides. Firm support from the bottom is highly necessary in order to provide balance stability.
- The computer is provided with a battery-powered real-time clock circuit. There is a danger of explosion if battery is incorrectly replaced. Replace only with the same or equivalent type recommended by the manufacturer. Discard used batteries according to the manufacturer's instructions.
- Output of the external power source shall be complied with ES1 and PS2 requirements, output rating is 19 Vdc, minimum 2.37 A, with minimum ambient temperature 50°C and altitude 5000m, and has to be evaluated according to IEC/EN 60950-1 and/or IEC/EN 62368-1.
- Ensure to connect the power cord of power adapter to a socket-outlet with earthing connection.

## Installation Recommendations

Ensure you have a stable, clean working environment. Dust and dirt can get into components and cause a malfunction. Use containers to keep small components separated.

Adequate lighting and proper tools can prevent you from accidentally damaging the internal components. Most of the procedures that follow require only a few simple tools, including the following:

- A Philips screwdriver
- A flat-tipped screwdriver
- A grounding strap
- An anti-static pad

Using your fingers can disconnect most of the connections. It is recommended that you do not use needle-nose pliers to disconnect connections as these can damage the soft metal or plastic parts of the connectors.



## Safety Precautions

1. Read these safety instructions carefully.
2. Keep this User Manual for later reference.
3. Disconnect this equipment from any AC outlet before cleaning. Use a damp cloth. Do not use liquid or spray detergents for cleaning.
4. For plug-in equipment, the power outlet socket must be located near the equipment and must be easily accessible.
5. Keep this equipment away from humidity.
6. Put this equipment on a stable surface during installation. Dropping it or letting it fall may cause damage.
7. The openings on the enclosure are for air convection to protect the equipment from overheating. DO NOT COVER THE OPENINGS.
8. Make sure the voltage of the power source is correct before connecting the equipment to the power outlet.
9. Place the power cord in a way so that people will not step on it. Do not place anything on top of the power cord. Use a power cord that has been approved for use with the product and that it matches the voltage and current marked on the product's electrical range label. The voltage and current rating of the cord must be greater than the voltage and current rating marked on the product.
10. All cautions and warnings on the equipment should be noted.
11. If the equipment is not used for a long time, disconnect it from the power source to avoid damage by transient overvoltage.
12. Never pour any liquid into an opening. This may cause fire or electrical shock.
13. Never open the equipment. For safety reasons, the equipment should be opened only by qualified service personnel.
14. If one of the following situations arises, get the equipment checked by service personnel:
  - a. The power cord or plug is damaged.
  - b. Liquid has penetrated into the equipment.
  - c. The equipment has been exposed to moisture.
  - d. The equipment does not work well, or you cannot get it to work according to the user's manual.
  - e. The equipment has been dropped and damaged.
  - f. The equipment has obvious signs of breakage.
15. Do not place heavy objects on the equipment.
16. The unit uses a three-wire ground cable which is equipped with a third pin to ground the unit and prevent electric shock. Do not defeat the purpose of this pin. If your outlet does not support this kind of plug, contact your electrician to replace your obsolete outlet.
17. **ATTENTION:** Risque d'explosion si la batterie est remplacée par un type incorrect. Mettre au rebus les batteries usagées selon les instructions.

**CAUTION:** Risk of explosion if battery is replaced by an incorrect type. Dispose of used batteries according to the instructions.

## Technical Support and Assistance

1. For the most updated information of NEXCOM products, visit NEXCOM's website at [www.nexcom.com](http://www.nexcom.com).
2. For technical issues that require contacting our technical support team or sales representative, please have the following information ready before calling:
  - Product name and serial number
  - Detailed information of the peripheral devices
  - Detailed information of the installed software (operating system, version, application software, etc.)
  - A complete description of the problem
  - The exact wordings of the error messages

### Warning!

1. Handling the unit: carry the unit with both hands and handle it with care.
2. Maintenance: to keep the unit clean, use only approved cleaning products or clean with a dry cloth.

## Conventions Used in this Manual



### Warning:

Information about certain situations, which if not observed, can cause personal injury. This will prevent injury to yourself when performing a task.



### Caution:

Information to avoid damaging components or losing data.



### Note:

Provides additional information to complete a task easily.

## Global Service Contact Information

### Headquarters

#### **NEXCOM International Co., Ltd.**

9F, No. 920, Zhongzheng Rd.,  
Zhonghe District, New Taipei City, 23586,  
Taiwan, R.O.C.  
Tel: +886-2-8226-7786  
Fax: +886-2-8226-7782  
www.nexcom.com

### Asia

#### **Taiwan**

#### **NexAIoT Headquarters**

#### **Industry 4.0 and Cloud Services**

13F, No.922, Zhongzheng Rd.,  
Zhonghe District, New Taipei City,  
23586, Taiwan, R.O.C.  
Tel: +886-2-8226-7796  
Fax: +886-2-8226-7926  
Email: jacobhuang@nexaiot.com  
www.nexaiot.com

#### **NexAIoT Co., Ltd.**

#### **Taichung Office**

16F, No.250, Sec.2, Chongde Rd.,  
Beitun District,  
Taichung City, 406, Taiwan, R.O.C.  
Tel: +886-4-2249-1179  
Fax: +886-4-2249-1172  
Email: jacobhuang@nexaiot.com  
www.nexaiot.com

#### **NexCOBOT Taiwan Co., Ltd.**

13F, No.916, Zhongzheng Rd.,  
Zhonghe District,  
New Taipei City, 23586, Taiwan, R.O.C.  
Tel: +886-2-8226-7786  
Fax: +886-2-8226-7926  
Email: jennyshern@nexcobot.com  
www.nexcobot.com

#### **GreenBase Technology Corp.**

13F, No.922, Zhongzheng Rd.,  
Zhonghe District,  
New Taipei City, 23586, Taiwan, R.O.C.  
Tel: +886-2-8226-7786  
Fax: +886-2-8226-7900  
Email: vivianlin@nexcom.com.tw  
www.nexcom.com.tw

#### **DivioTec Inc.**

19F-1A, No.97, Sec.4, ChongXin Rd.,  
Sanhong District,  
New Taipei City, 24161, Taiwan, R.O.C.  
Tel: +886-2-8976-3077  
Email: sales@diviotec.com  
www.diviotec.com

#### **AIoT Cloud Corp.**

13F, No.922, Zhongzheng Rd.,  
Zhonghe District,  
New Taipei City, 23586, Taiwan, R.O.C.  
Tel: +886-2-8226-7786  
Fax: +886-2-8226-7782  
Email: alantsai@aiotcloud.net  
www.aiotcloud.dev

#### **EMBUX TECHNOLOGY CO., LTD.**

13F, No.916, Zhongzheng Rd.,  
Zhonghe District,  
New Taipei City, 23586, Taiwan, R.O.C.  
Tel: +886-2-8226-7786  
Fax: +886-2-8226-7782  
Email: info@embux.com  
www.embux.com

#### **TMR TECHNOLOGIES CO., LTD.**

13F, No.916, Zhongzheng Rd.,  
Zhonghe District,  
New Taipei City, 23586, Taiwan, R.O.C.  
Tel: +886-2-8226-7786  
Fax: +886-2-8226-7782  
Email: services@tmrtek.com  
www.tmrtek.com

## China NEXSEC Incorporated

201, Floor 2, Unit 2, Building 15, Yard 3,  
Gaolizhang Road, Haidian District,  
Beijing, 100094, China  
Tel: +86-10-5704-2680  
Fax: +86-10-5704-2681  
Email: marketing@nexsec.cn  
www.nexsec.cn

## NEXCOM Shanghai

Room 406-407, Building C, No 154, Lane 953,  
Jianchuan Road, Minhang District,  
Shanghai, 201108, China  
Tel: +86-21-5278-5868  
Fax: +86-21-3251-6358  
Email: sales@nexcom.cn  
www.nexcom.cn

## NEXCOM Surveillance Technology Corp.

Floor 8, Building B3, Xiufeng Industrial Zone,  
GanKeng Community, Buji Street,  
LongGang District,  
ShenZhen, 518112, China  
Tel: +86-755-8364-7768  
Fax: +86-755-8364-7738  
Email: steveyang@nexcom.com.tw  
www.nexcom.cn

## NEXGOL Chongqing

1st Building No.999,  
Star Boulevard, Yongchuan Dist,  
Chongqing City, 402160, China  
Tel: +86-23-4960-9080  
Fax: +86-23-4966-5855  
Email: sales@nexgol.com.cn  
www.nexcom.cn

## Beijing NexGemo Technology Co.,Ltd.

Room 205, No.1, Fazhan Rd.,  
Beijing International Information Industry Base,  
Changping District,  
Beijing, 102206, China  
Tel: +86-10-8072-2025  
Fax: +86-10-8072-2022  
Email: sales@nexgemo.cn  
www.nexgemo.com

## Japan

### NEXCOM Japan

9F, Tamachi Hara Bldg.,  
4-11-5, Shiba Minato-ku,  
Tokyo, 108-0014, Japan  
Tel: +81-3-5419-7830  
Fax: +81-3-5419-7832  
Email: sales@nexcom-jp.com  
www.nexcom-jp.com

## America

### USA NEXCOM USA

46665 Fremont Blvd.,  
Fremont CA 94538, USA  
Tel: +1-510-656-2248  
Fax: +1-510-656-2158  
Email: sales@nexcom.com  
www.nexcomusa.com

## Package Contents

Before continuing, verify that the XPPC 10-100 package that you received is complete. Your package should have all the items listed in the following table.

Item	Part Number	Name	Qty
1	10W30XPPC26X0	XPPC 10-100-1 system	1
2	7400045002X00	45W Power Adapter	1

### Optional Accessories 1

Item	Part Number	Name	Description	Qty
1	5061711301X00	Panel Mount Bracket	Panel Mount BKT for XPPC 24-100 SIN Super Circle 30x20x6mm SECC T=1.6mm	6
2	6012200030X00	Bubble Wrap	Double Layer Antistatic Air Bag 11x(19+24)CM	1

### Optional Accessories 2

Item	Part Number	Name	Description	Qty
1	5040430525X00	Open Frame Bracket	Wall Mount Bracket For XPPC 10-100-1 VER:A SHYUNG SHUHN 156.1x40x16.40mm T=1.0mm SGCC NI	2
2	50311F0100X00	Screw	Round Head Screw w/Spring+Flat Washer Long Fei:P3x6L P3x6 iso/SW6x0.5 NI	4
3	6012200053X00	Zipper Bag	PE Zipper Bag #3 100x70mm, w/China RoHS Symbol	1
4	6012200030X00	Bubble Wrap	Double Layer Antistatic Air Bag 11x(19+24)CM	1

## Ordering Information

The following below provides ordering information for XPPC 10-100.

### **XPPC 10-100-1 (P/N: 10W30XPPC26X0)**

10.1" TFT panel PC, P-CAP, Celeron J3455 w/touch IC 81W60, w/optical bonding

### **Panel Mount Kit (P/N: 88W30XPPC02X0)**

### **Open Frame Kit (P/N: 88W30XPPC03X0)**

# CHAPTER 1: PRODUCT INTRODUCTION

## XPPC 10-100

### Overview



### Key Features

- 10.1" TFT WXGA 16:10 panel
- 10 Points P-Cap multi-touch with slim bezel design
- IP65 protection on the front
- Supports: VESA/panel/open frame mount
- Intel® Celeron® processor J3455, Quad Core, 1.50 GHz
- 1 x DDR3L up to 8GB, M.2Key M 2242 for storage device
- Support power input 19 VDC

## Hardware Specifications

### Panel

- LCD size: AUO G-series 10.1", 16:10
- Resolution: WXGA 1280 x 800
- Luminance: 400cd/m<sup>2</sup>
- Contrast ratio: 800
- LCD color: 16.7M
- Viewing angle: 89 (U), 89 (D), 89 (L), 89 (R)
- Backlight: LED

### Touch Screen

- Touch IC: EXC81W60
- 10 Points P-Cap (projected capacitive touch)
- Optical bonding
- Glass surface treatment: AS  
(Anti-smudge coating for easy cleaning)

### System

- CPU: on-board Intel® Celeron® processor J3455, 1.50GHz, 2M cache
- Graphics: Intel® HD Graphics

### Main Memory

- 1 x SO-DIMM socket supports up to 8GB DDR3L 1866 MHz, non-ECC and un-buffered memory

### Storage Device

- 1 x M.2 Key M 2242 SSD (support SATA 3.0)

### Expansion

- 1 x mini-PCIe full-size connector with SIM slot (full-size) on board, supports Wi-Fi/LTE module

### Rear I/O

- LED for power on/off
- Power switch
- 19V DC-in power jack lock type
- 2 x RJ45 with LEDs for Gigabit LAN
- 1 x HDMI 2.0, resolution 4096 x 2160 60Hz
- 2 x USB 3.0
- 1 x Line-out
- COM 1: RS232/422/485

### Front I/O

- 2 x Antenna holes

### Mechanical

- Color/material: black silver/metal sheet
- Support
  - VESA mount 75mm x 75mm
  - Panel mount
  - Open frame

### Environment

- Vibration
  - IEC 60068-2-64
  - 2Grms @ sine, 5~500Hz, 1hr/axis
  - 2.2Grms @ random condition, 5~500Hz, 0.5hr/axis (non-operating)
- Shock
  - IEC 60068-2-27
  - 20g peak acceleration (11 msec. duration)



- Temperature
  - Operating temperature with 0.7 m/s air flow : 0°C~ 50°C
  - Storage temperature: -20°C~60°C
- Operating humidity: 10%~90% relative humidity, non-condensing limits to be at 90%

### **Dimensions**

- System: 260.3mm x 178.3mm x 44.65mm
- System weight: 2 kg
- Package: 335mm x 302mm x 160mm
- Package weight: 3 kg

### **Power Supply**

- 1 x 45W AC/DC lockable adapter included in accessory
- Input: 100VAC to 240VAC
- Output: DC+19VDC

### **Certification**

- CE (EN55035 + EN55032)
- FCC Class A (EMI part 15B)
- LVD (EN62368-1)

### **Operating System Support**

- Windows 10 64-bit
- Linux

## Knowing Your XPPC 10-100

### Rear Top



### Rear Bottom

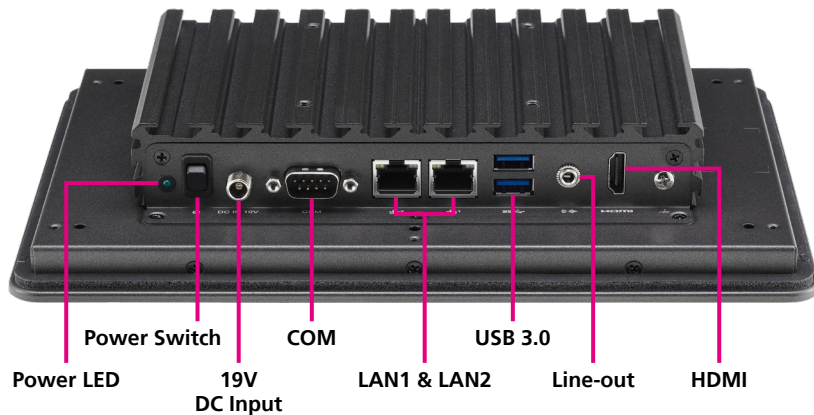

#### Antenna Holes

The external antenna mounting holes are used to mount and connect optional Wi-Fi antennas.

#### Power LED

Used to indicate the power status of the system.

#### Power Switch

Press to power-on or power-off the system.

#### 19V DC Input

Used to plug a DC power cord.

#### COM

DB9 port used to connect RS232/422/485 compatible devices.

#### LAN1 & LAN2

Used to connect the system to a local area network.

#### USB 3.0

Used to connect USB 3.0/2.0 devices.

#### Line-out

Used to connect a headphone or a speaker.

#### HDMI

Used to connect an HDMI interface monitor.

# Mechanical Dimensions

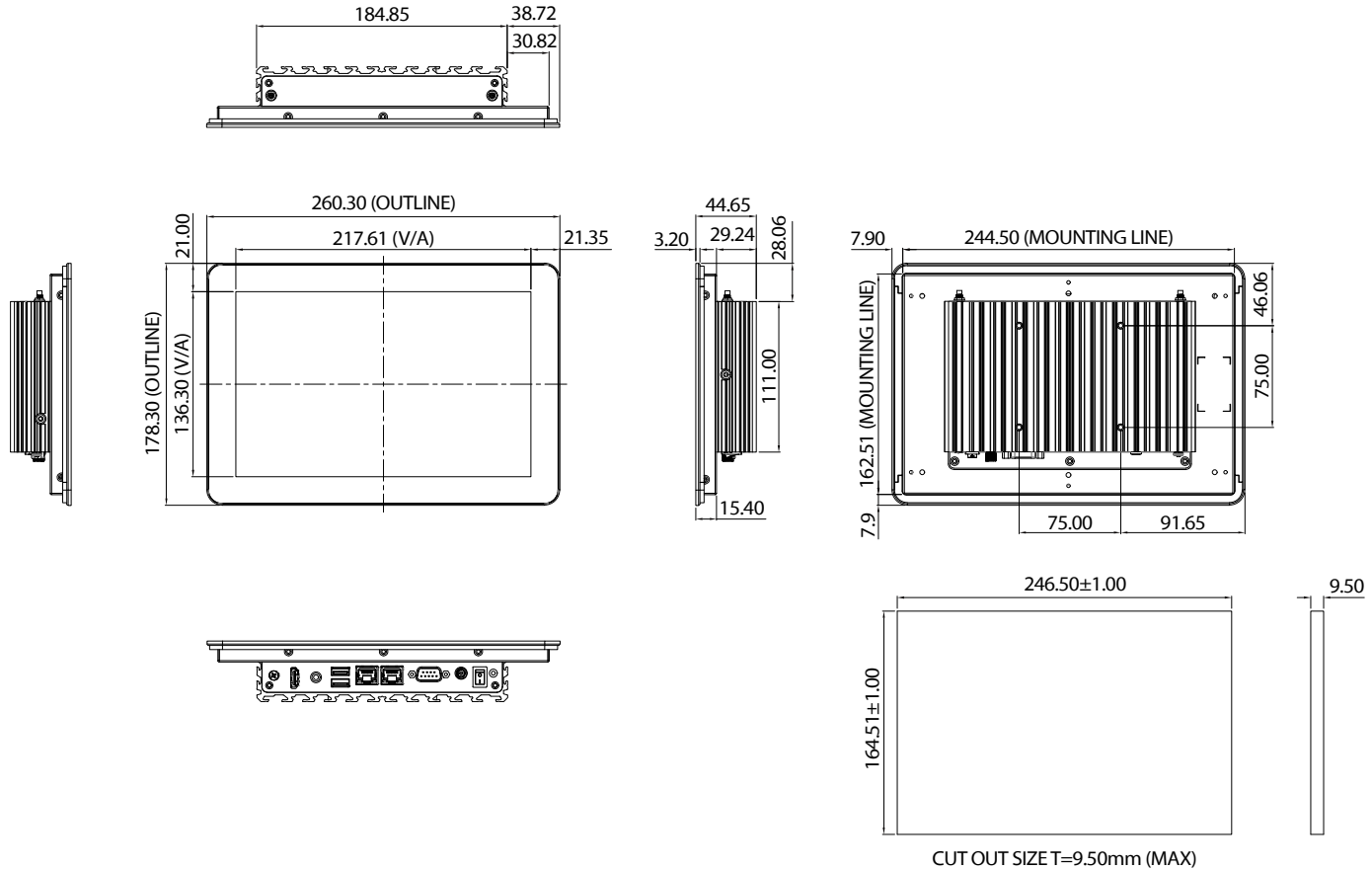

## CHAPTER 2: JUMPERS AND CONNECTORS

This chapter describes how to set the jumpers and connectors on the XPPC 10-100 motherboard.

### Before You Begin

- Ensure you have a stable, clean working environment. Dust and dirt can get into components and cause a malfunction. Use containers to keep small components separated.
- Adequate lighting and proper tools can prevent you from accidentally damaging the internal components. Most of the procedures that follow require only a few simple tools, including the following:
  - A Philips screwdriver
  - A flat-tipped screwdriver
  - A set of jewelers screwdrivers
  - A grounding strap
  - An anti-static pad
- Using your fingers can disconnect most of the connections. It is recommended that you do not use needle-nosed pliers to disconnect connections as these can damage the soft metal or plastic parts of the connectors.
- Before working on internal components, make sure that the power is off. Ground yourself before touching any internal components, by touching a metal object. Static electricity can damage many of the electronic components. Humid environments tend to have less static electricity than

dry environments. A grounding strap is warranted whenever danger of static electricity exists.

### Precautions

Computer components and electronic circuit boards can be damaged by discharges of static electricity. Working on computers that are still connected to a power supply can be extremely dangerous.

Follow the guidelines below to avoid damage to your computer or yourself:

- Always disconnect the unit from the power outlet whenever you are working inside the case.
- If possible, wear a grounded wrist strap when you are working inside the computer case. Alternatively, discharge any static electricity by touching the bare metal chassis of the unit case, or the bare metal body of any other grounded appliance.
- Hold electronic circuit boards by the edges only. Do not touch the components on the board unless it is necessary to do so. Don't flex or stress the circuit board.
- Leave all components inside the static-proof packaging that they shipped with until they are ready for installation.
- Use correct screws and do not over tighten screws.

## Jumper Settings

A jumper is the simplest kind of electric switch. It consists of two metal pins and a cap. When setting the jumpers, ensure that the jumper caps are placed on the correct pins. When the jumper cap is placed on both pins, the jumper is short. If you remove the jumper cap, or place the jumper cap on just one pin, the jumper is open.

Refer to the illustrations below for examples of what the 2-pin and 3-pin jumpers look like when they are short (on) and open (off).

Two-Pin Jumpers: Open (Left) and Short (Right)

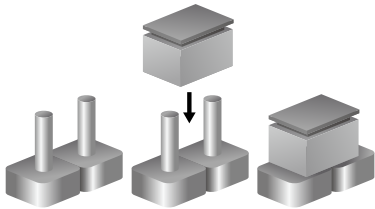

Three-Pin Jumpers: Pins 1 and 2 are Short

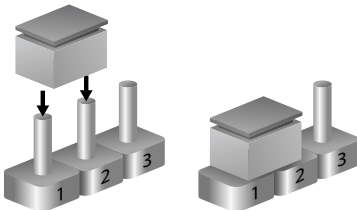

# Locations of the Jumpers and Connectors for XPPC 10-100

The figure below is the top and bottom view of the mainboard used in XPPC 10-100. It shows the locations of the jumpers and connectors.

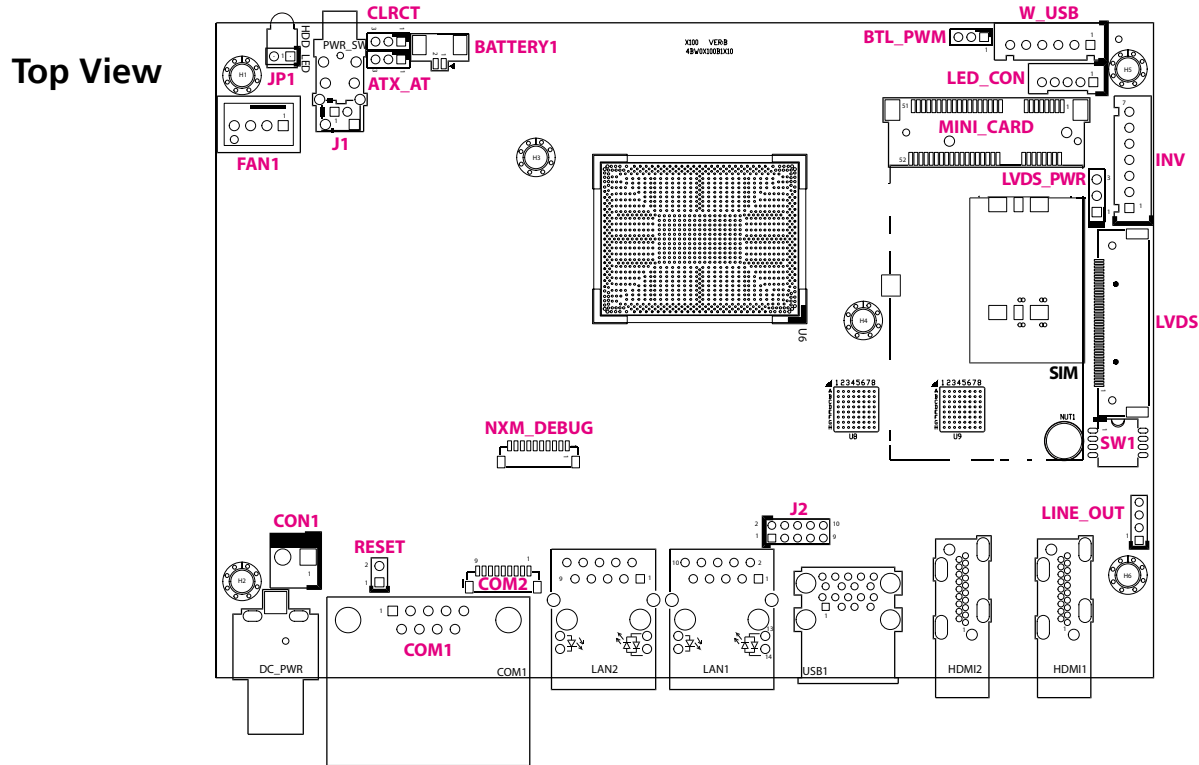

### Bottom View

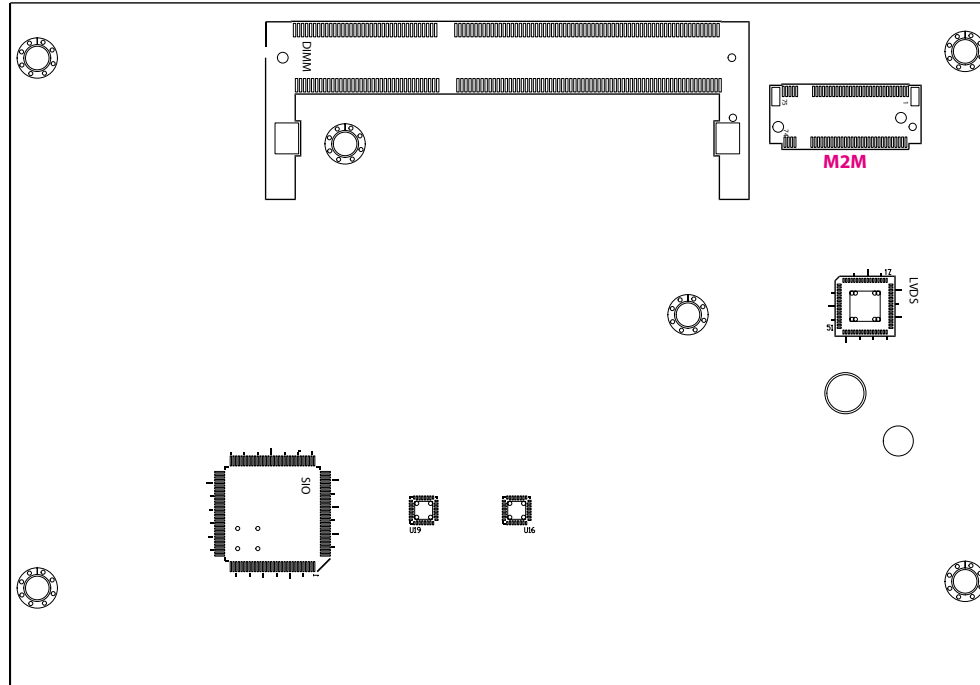

## Jumpers & DIP Switches

### AT/ATX Mode Select

Connector type: 1x3 3-pin header, 2.0mm pitch  
Connector location: ATX\_AT

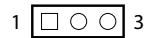

Pin	Settings
1-2 On	ATX Mode
2-3 On	AT Mode

1-2 On: default

### Clear CMOS

Connector type: 1x3 3-pin header, 2.0mm pitch  
Connector location: CLRTC

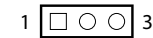

Pin	Settings
1-2 On	Normal
2-3 On	Clear CMOS

1-2 On: default



## LVDS Panel Voltage Select

Connector type: 1x3 3-pin header, 2.54mm pitch

Connector location: LVDS\_PWR

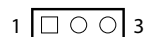

Pin	Settings
1-2 On	3.3V
2-3 On	5V

1-2 On: default

## Backlight Control Voltage Select (Dimming)

Connector type: 1x3 3-pin header, 2.0mm pitch

Connector location: BLT\_PWM



Pin	Settings
1-2 On	3.3V
2-3 On	5V

2-3 On: default

## LVDS Resolution Select

Connector type: 4-pin DIP switch

Connector location: SW1

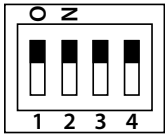

SW [3:0]	SW1 [3]	SW1 [2]	SW1 [1]	SW1 [0]	Function
0000	ON	ON	ON	ON	800 x 600 6-bit Single Port
0001	ON	ON	ON	OFF	1024 x 768 6-bit Single Port
0010	ON	ON	OFF	ON	1024 x 768 8-bit Single Port
0011	ON	ON	OFF	OFF	1280 x 1024 6-bit Single Port
0100	ON	OFF	ON	ON	1280 x 800 6-bit Single Port
0101	ON	OFF	ON	OFF	1280 x 800 8-bit Single Port
0110	ON	OFF	OFF	ON	1280 x 1024 8-bit Dual Port
0111	ON	OFF	OFF	OFF	1366 x 768 6-bit Single Port
1000	OFF	ON	ON	ON	1366 x 768 8-bit Single Port
1001	OFF	ON	ON	OFF	1440 x 900 8-bit Dual Port
1010	OFF	ON	OFF	ON	1400 x 1050 8-bit Dual Port
1011	OFF	ON	OFF	OFF	1600 x 900 8-bit Dual Port
1100	OFF	OFF	ON	ON	1680 x 1050 8-bit Dual Port
1101	OFF	OFF	ON	OFF	1600 x 1200 8-bit Dual Port
1110	OFF	OFF	OFF	ON	1920 x 1080 8-bit Dual Port
1111	OFF	OFF	OFF	OFF	1920 x 1200 8-bit Dual Port

## Connector Pin Definitions

### External Connector

#### COM1 DB9 Male Connector

Connector type: DB-9 port, 9-pin D-Sub

Connector location: COM1

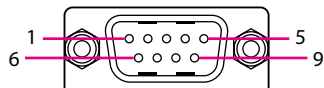

Pin	Definition	Pin	Definition
1	DCD	2	RXD
3	TXD	4	DTR
5	GND	6	DSR
7	RTS	8	CTS
9	RI		

## Internal Connectors

### LVDS Inverter Connector

Connector type: 1x7 7-pin header JST, 2.5mm pitch

Connector location: INV

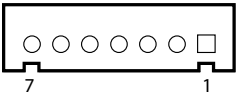

Pin	Definition	Pin	Definition
1	5V	2	12V
3	12V	4	Backlight Control
5	GND	6	GND
7	Backlight Enable		

### System Reset Header

Connector type: 1x2 2-pin header, 2.54mm pitch

Connector location: RESET



Pin	Definition
1	RESET#
2	GND

## LED Connector

Connector type: 1x5 5-pin header JST, 2.0mm pitch

Connector location: LED\_CON

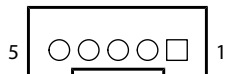

Pin	Definition	Pin	Definition
1	HDD_LED-	2	HDD_LED+
3	GND	4	Standby LED
5	PWR LED		

## HDD LED Connector

Connector type: 1x2 2-pin header, 2.54mm pitch

Connector location: JP1



Pin	Definition
1	HDD_LED+
2	HDD_LED-

## Line-out Connector

Connector type: 1x4 4-pin header, 2.0mm pitch

Connector location: LINE\_OUT

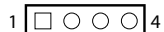

Pin	Definition	Pin	Definition
1	LOUT_L	2	GND
3	LOUT_JD	4	LOUT_R

## USB Connector

Connector type: 2x5 10-pin header

Connector location: J2

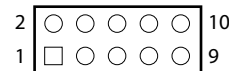

Pin	Definition	Pin	Definition
1	+5V_USB2_P45	2	GND
3	S_USB2DN4	4	GND
5	S_USB2DP4	6	S_USB2DP5
7	GND	8	S_USB2DN5
9	GND	10	+5V_USB2_P45

## USB Touch

Connector type: 1x6 6-pin header JST, 2.5mm pitch  
Connector location: W\_USB

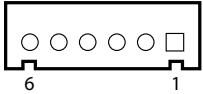

Pin	Definition	Pin	Definition
1	+5V_USB2_P2	2	S_USB2DN2
3	S_USB2DP2	4	S_USB2DN6
5	S_USB2DP6	6	GND

## System Power Button Header

Connector type: 1x2 2-pin header JST, 2.0mm pitch  
Connector location: J1

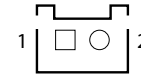

Pin	Definition
1	GND
2	PWRBTN#

## DC Power Input

Connector type: 1x2 2-pin header, 3.96mm pitch  
Connector location: CON1

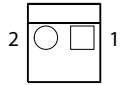

Pin	Definition
1	GND
2	+DC_IN

## FAN Connector

Connector type: 1x4 4-pin header, 2.54mm pitch  
Connector location: FAN1

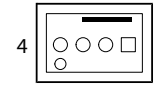

Pin	Definition	Pin	Definition
1	GND	2	+12V
3	FAN SPEED DETECT	4	FAN SPEED CONTROL



## Debug Port/LPC Bus Connector

Connector type: 1x10 10-pin header, 1.0mm pitch

Connector location: NXM\_DEBUG



Pin	Definition	Pin	Definition
1	+3V	2	SERIRQ
3	LAD0	4	LAD1
5	LAD2	6	LAD3
7	LFRAME#	8	25MHZ
9	PLTRST#	10	GND

## COM Port Connector

Connector type: 1x9 9-pin header, 1.0mm pitch

Connector location: COM2

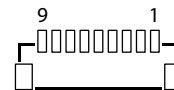

Pin	Definition	Pin	Definition
1	DCD	2	RXD
3	TXD	4	DTR
5	GND	6	DSR
7	RTS	8	CTS
9	RI		

## Battery Connector

Connector type: 1x2 2-pin header, 1.25mm pitch

Connector location: BATTERY1

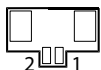

Pin	Definition
1	BAT
2	GND

## LVDS Panel Connector

Connector type: 1x40 40-pin header, 0.5mm pitch

Connector location: LVDS

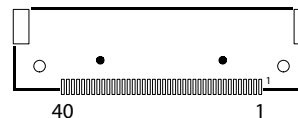

Pin	Definition	Pin	Definition
1	LVDS0_D3+	2	LVDS0_D3-
3	LVDS0_D2+	4	LVDS0_D2-
5	LVDS0_D1+	6	LVDS0_D1-
7	LVDS0_D0+	8	LVDS0_D0-
9	LVDS1_D3+	10	LVDS1_D3-
11	LVDS1_D2+	12	LVDS1_D2-
13	LVDS1_D1+	14	LVDS1_D1-
15	LVDS1_D0+	16	LVDS1_D0-
17	GND	18	+V_PANEL (3.3V or 5V)
19	+V_PANEL (3.3V or 5V)	20	+V_PANEL (3.3V or 5V)
21	GND	22	3.3V
23	GND	24	GND
25	GND	26	LVDS0_CLK+
27	LVDS0_CLK-	28	GND
29	GND	30	GND
31	SMBUS_CLK	32	Backlight Enable
33	Backlight Control	34	LVDS1_CLK+
35	LVDS1_CLK-	36	+12V
37	+12V	38	+12V
39	NC	40	SMBUS_DAT

## Mini-PCIe Connector

Connector location: MINI\_CARD

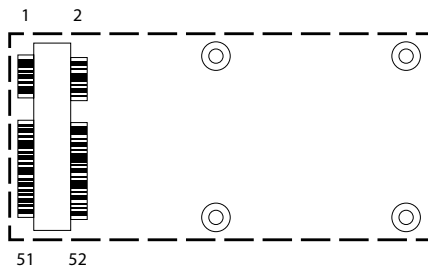

Pin	Definition	Pin	Definition
1	WAKE#	2	+3VSB
3	NC	4	GND
5	NC	6	+1.5V
7	NC	8	SIM_PWR
9	GND	10	SIM_DATA
11	REFCLK-	12	SIM_CLK
13	REFCLK+	14	SIM_RESET
15	GND	16	SIM_VPP
17	NC	18	GND
19	NC	20	WLAN_DISABLE#
21	GND	22	RESET#
23	PERn0	24	+3VSB
25	PERp0	26	GND

Pin	Definition	Pin	Definition
27	GND	28	+1.5V
29	GND	30	SMB_CLK
31	PETn0	32	SMB_DATA
33	PETp0	34	GND
35	GND	36	USB_D-
37	GND	38	USB_D+
39	+3VSB	40	GND
41	+3VSB	42	NC
43	GND	44	NC
45	NC	46	NC
47	NC	48	+1.5V
49	NC	50	GND
51	NC	52	+3VSB

## M.2 Connector (Key M)

Connector location: M2M

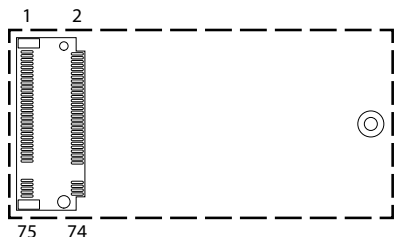

Pin	Definition	Pin	Definition
1	GND	2	+3VSB
3	GND	4	+3VSB
5	NC	6	NC
7	NC	8	NC
9	GND	10	M2M_LED#
11	NC	12	+3VSB
13	NC	14	+3VSB
15	GND	16	+3VSB
17	NC	18	+3VSB
19	NC	20	NC
21	GND	22	NC
23	NC	24	NC
25	NC	26	NC
27	GND	28	NC
29	NC	30	NC
31	NC	32	NC
33	GND	34	NC
35	NC	36	NC
37	NC	38	DEVSLP

Pin	Definition	Pin	Definition
39	GND	40	NC
41	SATA_RXP	42	NC
43	SATA_RXN	44	NC
45	GND	46	NC
47	SATA_TXN	48	NC
49	SATA_TXP	50	RESET#
51	GND	52	NC
53	NC	54	NC
55	NC	56	NC
57	GND	58	NC
67	NC	68	NC
69	NC	70	+3VSB
71	GND	72	+3VSB
73	GND	74	+3VSB
75	GND		

## CHAPTER 3: SYSTEM SETUP

### Removing the Top Cover from the Chassis

1. Remove the 7 screws from the top cover, then lift up the system chassis box to access the mainboard.

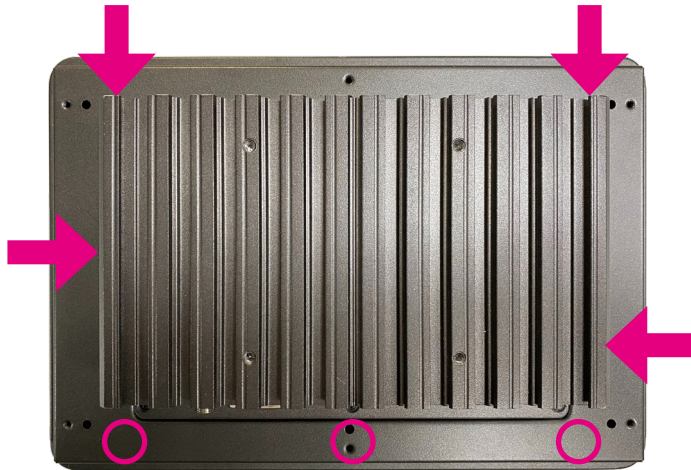

### Installing Memory Module & Storage Drive

1. With the top cover removed, install a memory module and an M.2 storage drive to the SO-DIMM and M.2 slot respectively.

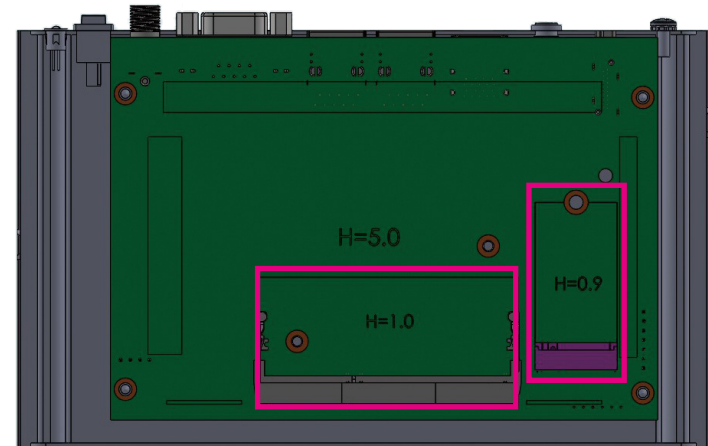

Prior to removing the top cover, make sure the unit's power is off and disconnected from the power sources to prevent electric shock or system damage.

## Installing a Wi-Fi or LTE Module (Mini-PCle)

1. With the top cover removed, unscrew the 4 screws on the mainboard and the 2 screws on the IO bracket, then remove the mainboard from the chassis.

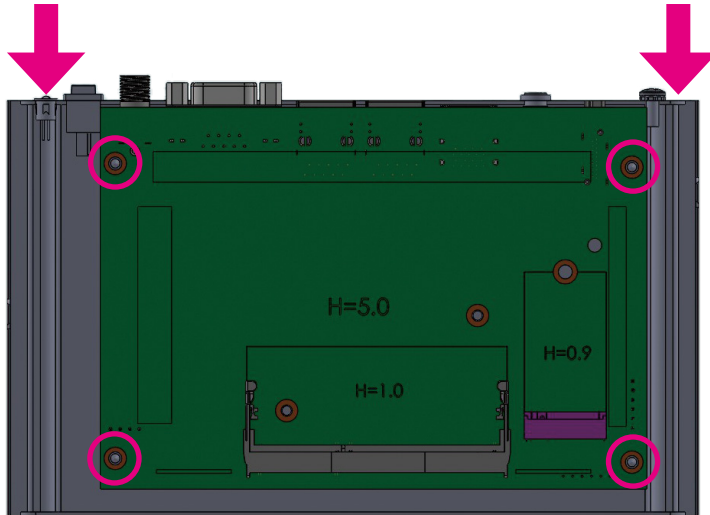

2. Locate the mini-PCle slot on the mainboard and install the Wi-Fi or LTE module into the slot. Then secure the module with a screw.

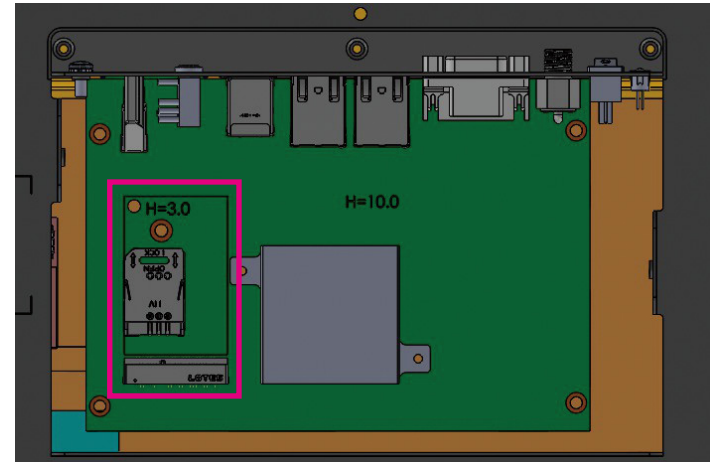

## Installing VESA Mount Kit

1. Align the mounting holes on the VESA mount bracket to the VESA mounting holes on the back of the panel PC, then secure the VESA mount bracket with screws.

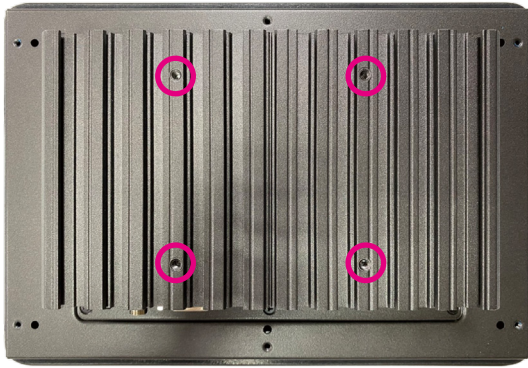

Recommended screws for the VESA mount kit:  
4 \* M4x8 screws.

## Installing Open Frame Kit

1. Turn to the rear side of the panel PC and align the mounting holes on the open frame bracket to the open frame mounting holes on the panel PC, then secure the open frame bracket with screws.

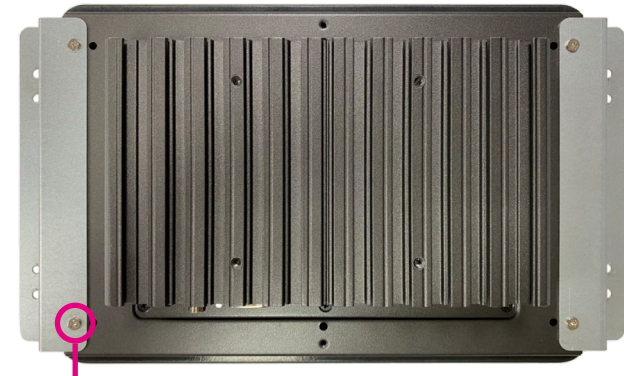
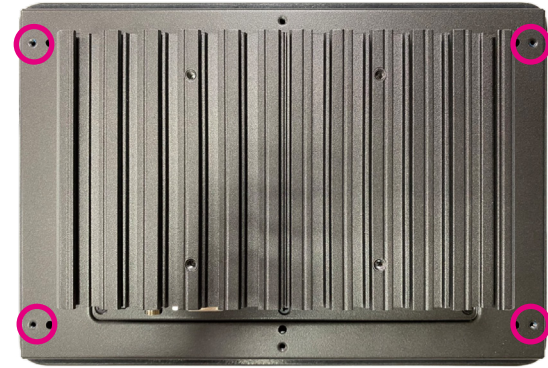

4 \* Screws (I3x5ISO+Nylok)

## System Dimensions with Open Frame Kit

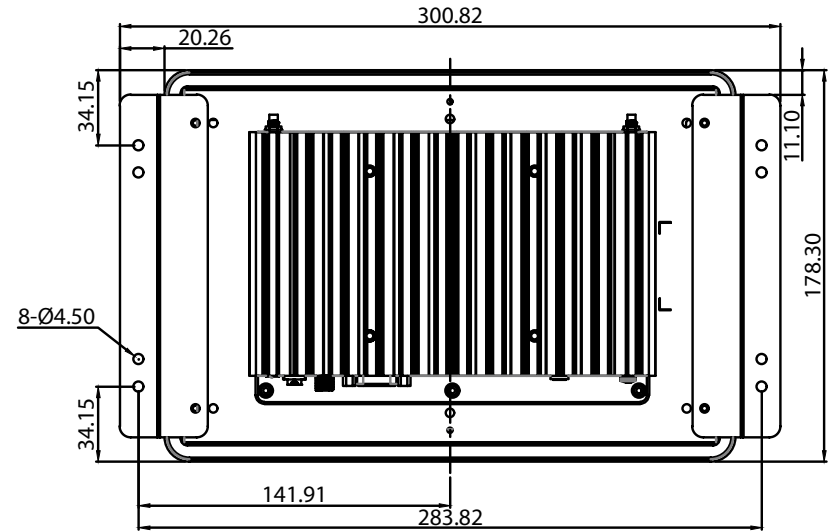
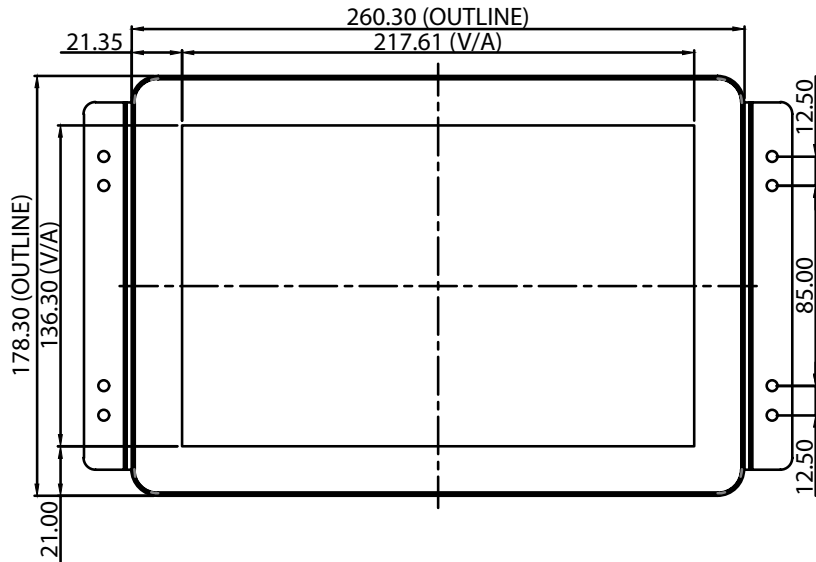



## Panel Mounting

1. Select a place on the panel where you will mount the panel PC.
2. Cut out a shape on the panel that corresponds to the panel PC's rear dimensions.

The thickness of the panel (e.g. steel board, plank, acrylic board, wall, etc.) where you will mount the panel PC must not exceed 9.5mm. If the distance between the front bezel and panel mount hole is too wide, it will not fit the panel mount kit.

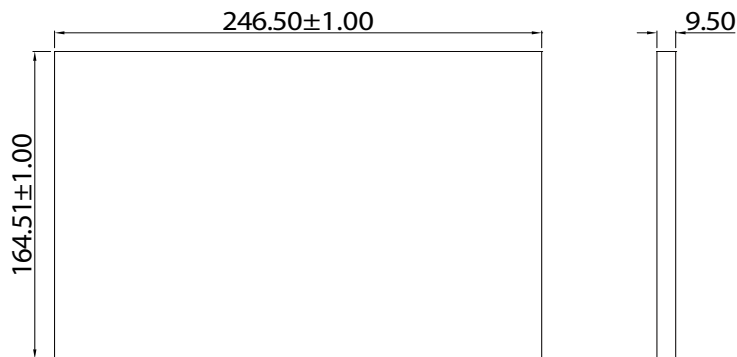

CUT OUT SIZE=9.50mm (MAX)

3. Slide the panel PC through the hole until it is properly fitted against the panel.

4. Position the mounting clamps along the rear edges of the panel PC. The first and second clamps must be positioned and secured diagonally prior to mounting the rest of the clamps.

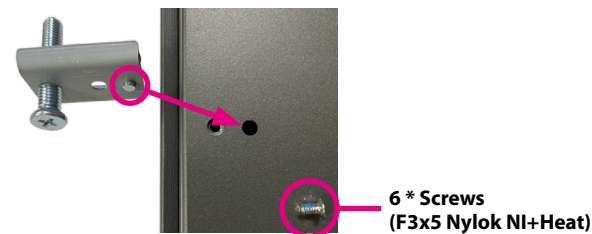
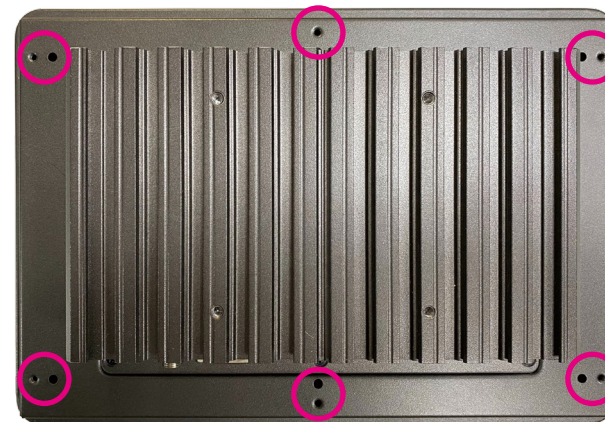

5. Tighten the clamp's screw until it touches the panel.

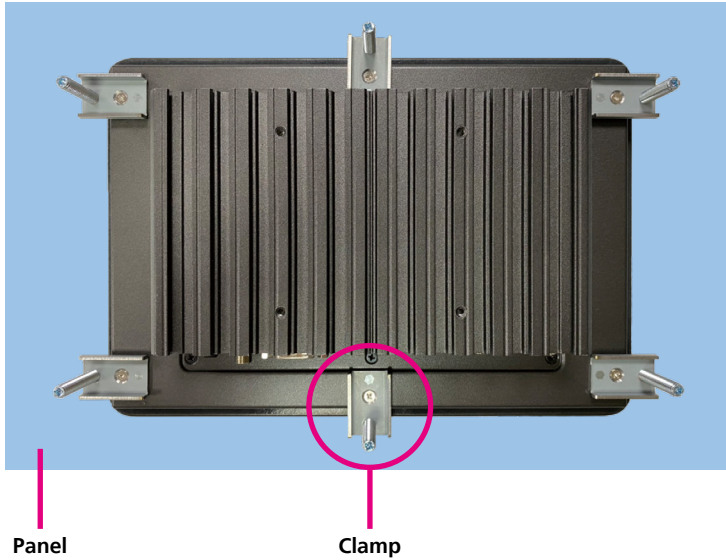

Do not overtighten the screws to prevent damaging the Panel PC.

# CHAPTER 4: BIOS SETUP

This chapter describes how to use the BIOS setup program for XPPC 10-100. The BIOS screens provided in this chapter are for reference only and may change if the BIOS is updated in the future.

To check for the latest updates and revisions, visit the NEXCOM website at [www.nexcom.com.tw](http://www.nexcom.com.tw).

## About BIOS Setup

The BIOS (Basic Input and Output System) Setup program is a menu driven utility that enables you to make changes to the system configuration and tailor your system to suit your individual work needs. It is a ROM-based configuration utility that displays the system's configuration status and provides you with a tool to set system parameters.

These parameters are stored in non-volatile battery-backed-up CMOS RAM that saves this information even when the power is turned off. When the system is turned back on, the system is configured with the values found in CMOS.

With easy-to-use pull down menus, you can configure such items as:

- Hard drives, diskette drives, and peripherals
- Video display type and display options
- Password protection from unauthorized use
- Power management features

The settings made in the setup program affect how the computer performs. It is important, therefore, first to try to understand all the setup options, and second, to make settings appropriate for the way you use the computer.

## When to Configure the BIOS

- This program should be executed under the following conditions:
  - When changing the system configuration
  - When a configuration error is detected by the system and you are prompted to make changes to the setup program
  - When resetting the system clock
  - When redefining the communication ports to prevent any conflicts
  - When making changes to the Power Management configuration
  - When changing the password or making other changes to the security setup

Normally, CMOS setup is needed when the system hardware is not consistent with the information contained in the CMOS RAM, whenever the CMOS RAM has lost power, or the system features need to be changed.

## Default Configuration

Most of the configuration settings are either predefined according to the Load Optimal Defaults settings which are stored in the BIOS or are automatically detected and configured without requiring any actions. There are a few settings that you may need to change depending on your system configuration.

## Entering Setup











When the system is powered on, the BIOS will enter the Power-On Self Test (POST) routines. These routines perform various diagnostic checks; if an error is encountered, the error will be reported in one of two different ways:

- If the error occurs before the display device is initialized, a series of beeps will be transmitted.
- If the error occurs after the display device is initialized, the screen will display the error message.

Powering on the computer and immediately pressing <Del> allows you to enter Setup.

Press the  key to enter Setup:

## Legends

Key	Function
	Moves the highlight left or right to select a menu.
	Moves the highlight up or down between sub-menus or fields.
	Exits the BIOS Setup Utility.
	Scrolls forward through the values or options of the highlighted field.
	Scrolls backward through the values or options of the highlighted field.
	Selects a field.
	Displays General Help.
	Load previous values.
	Load optimized default values.
	Saves and exits the Setup program.
	Press <Enter> to enter the highlighted sub-menu

## Scroll Bar

When a scroll bar appears to the right of the setup screen, it indicates that there are more available fields not shown on the screen. Use the up and down arrow keys to scroll through all the available fields.

## Submenu

When “▶” appears on the left of a particular field, it indicates that a submenu which contains additional options are available for that field. To display the submenu, move the highlight to that field and press  .

## BIOS Setup Utility

Once you enter the AMI BIOS Setup Utility, the Main Menu will appear on the screen. The main menu allows you to select from several setup functions and one exit. Use arrow keys to select among the items and press  to accept or enter the submenu.

### Main

The Main menu is the first screen that you will see when you enter the BIOS Setup Utility.

Aptio Setup Utility - Copyright (C) 2020 American Megatrends, Inc.					
Main	Advanced	Chipset	Security	Boot	Save & Exit
<b>BIOS Information</b>		American Megatrends		Set the Date. Use Tab to switch between Date elements.	
BIOS Vendor	5.12		Default Ranges:		
Core Version	UEFI 2.5; PI 1.4		Year: 2005-2099		
Compliance	X100-008 x64		Months: 1-12		
Project Version	01/09/2020 10:35:33		Days: dependent on month		
Build Date and Time	Administrator				
Access Level					
<b>Platform firmware Information</b>		F1		←→: Select Screen	
BXT SOC	3.0.13.1144		↑↓: Select Item		
TXE FW	10.0.1036		Enter: Select		
GOP			+/-: Change Opt.		
<b>Memory Information</b>		4096 MB		F1: General Help	
Total Memory	1866 MHz		F2: Previous Values		
Memory Speed			F3: Optimized Defaults		
System Date	[Mon 01/13/2020]		F4: Save & Exit		
System Time	[16:42:16]		ESC: Exit		

Version 2.18.1263. Copyright (C) 2020 American Megatrends, Inc.

### System Date

The date format is <day>, <month>, <date>, <year>. Day displays a day, from Monday to Sunday. Month displays the month, from January to December. Date displays the date, from 1 to 31. Year displays the year, from 2005 to 2099.

### System Time

The time format is <hour>, <minute>, <second>. The time is based on the 24-hour military-time clock. For example, 1 p.m. is 13:00:00. Hour displays hours from 00 to 23. Minute displays minutes from 00 to 59. Second displays seconds from 00 to 59.

## Advanced

The Advanced menu allows you to configure your system for basic operation. Some entries are defaults required by the system board, while others, if enabled, will improve the performance of your system or let you set some features according to your preference.



Setting incorrect field values may cause the system to malfunction.



### Restore AC Power Loss

Configures the power state when power is re-applied after a power failure.

## ACPI Settings

This section is used to configure ACPI settings.

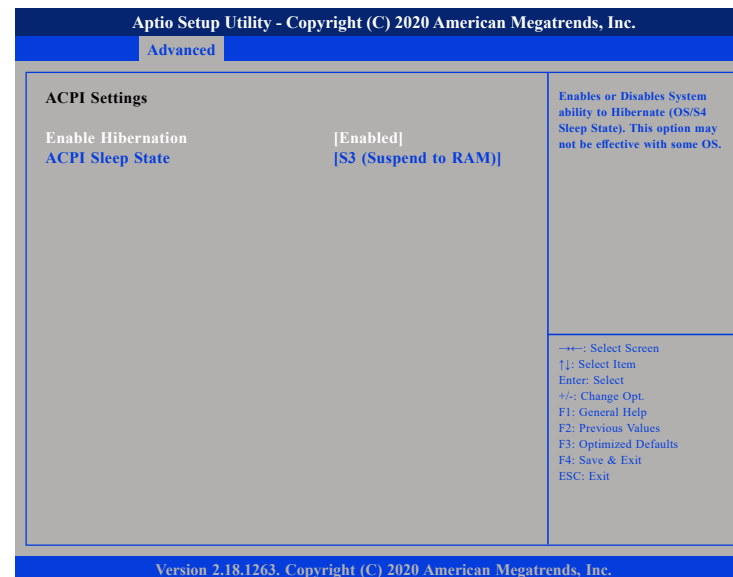

### Enable Hibernation

Enables or disables system ability to hibernate (OS/S4 Sleep State). This option may not be effective with some operating systems.

### ACPI Sleep State

Select the highest ACPI sleep state the system will enter when the suspend button is pressed. The options are Suspend Disabled and S3 (Suspend to RAM).

## NCT6793D Super IO Configuration

This section is used to configure the serial ports.

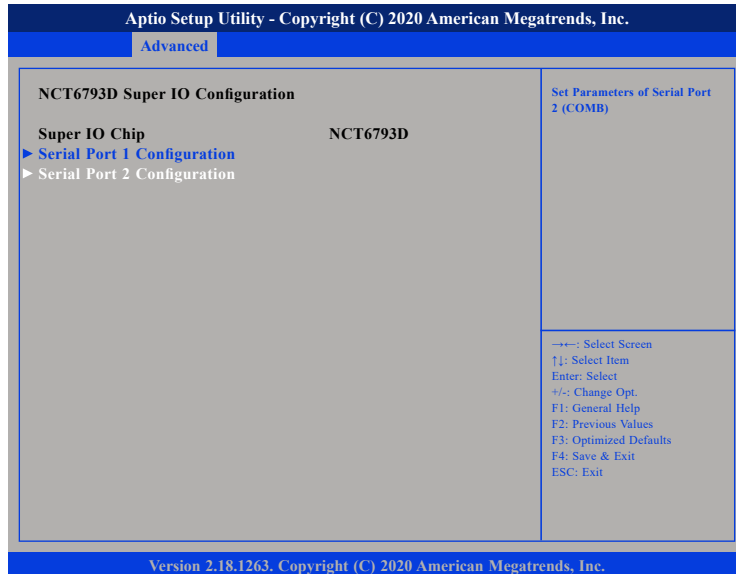

### Super IO Chip

Displays the Super I/O chip used on the board.

## Serial Port 1 Configuration

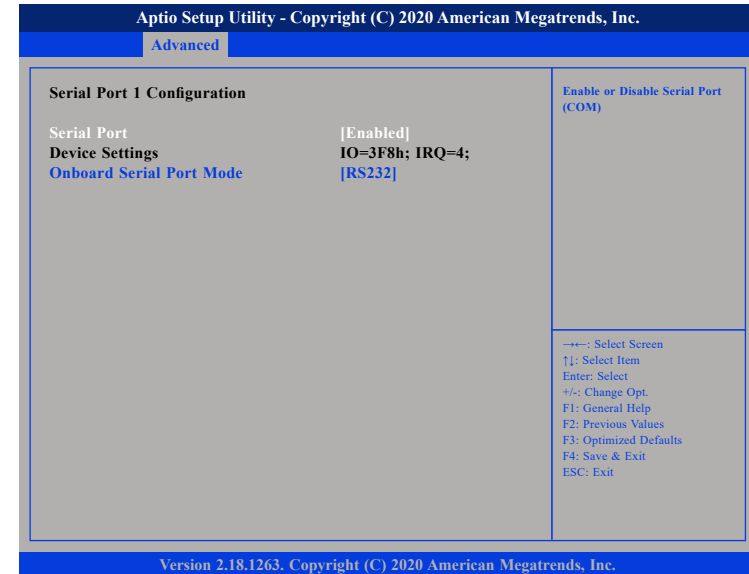

### Serial Port

Enables or disables the serial COM port.

### Device Settings

Displays the IO address and IRQ of the serial COM port.

### Onboard Serial Port Mode

Select this to change the serial port mode to RS232, RS422, RS485 No Terminator or RS485 With Terminator.



## Serial Port 2 Configuration

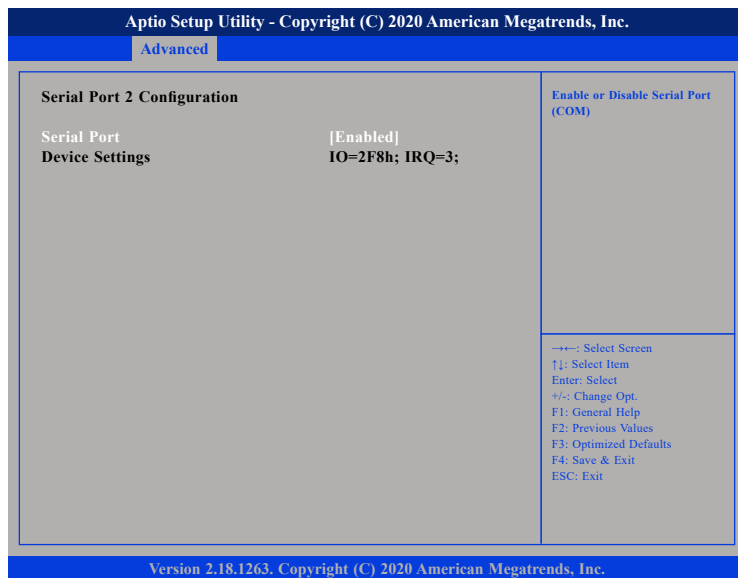

### Serial Port

Enables or disables the serial COM port.

### Device Settings

Displays the IO address and IRQ of the serial COM port.

## Hardware Monitor

This section is used to monitor hardware status such as temperature, fan speed and voltages.

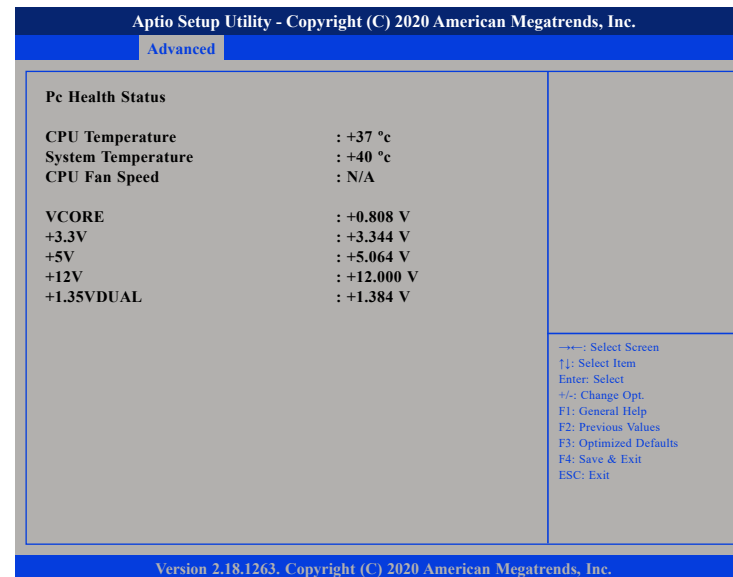

### CPU Temperature

Detects and displays the current CPU temperature.

### System Temperature

Detects and displays the current system temperature.

### CPU Fan Speed

Detects and displays the current CPU fan speed.

### VCORE to 1.35VDUAL

Detects and displays the output voltages.

## S5 RTC Wake Settings

This section is used to configure the system to wake from S5 using RTC alarm.

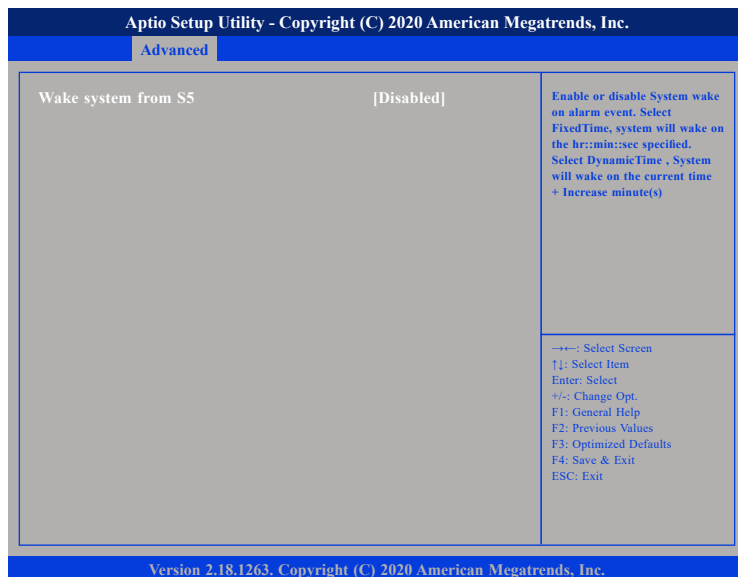

### Wake system from S5

Enables or disables system wake on alarm event. When FixedTime is selected, system will wake on the hr::min::sec specified. When DynamicTime is selected, system will wake on the current time + Increase minute(s).

## CPU Configuration

This section is used to view CPU status and configure CPU parameters.



### Active Processor Cores

Select the number of cores to enable in each processor package.

### Intel® Virtualization Technology

When this field is set to Enabled, the VMM can utilize the additional hardware capabilities provided by Vanderpool Technology.

### VT-d

Enables or disables VT-d function on MCH.

## Socket 0 CPU Information

Display information on the CPU installed on socket 0.

Aptio Setup Utility - Copyright (C) 2020 American Megatrends, Inc.

Advanced

**Socket 0 CPU Information**

Intel(R) Celeron(R) CPU J3455E @ 1.50GHz	
CPU Signature	506CA
Microcode Patch	1A
Max CPU Speed	1500 MHz
Min CPU Speed	800 MHz
Processor Cores	4
Intel HT Technology	Not Supported
Intel VT-x Technology	Supported
L1 Data Cache	24 kB x 4
L1 Code Cache	32 kB x 4
L2 Cache	1024 kB x 2
L3 Cache	Not Present

→←: Select Screen  
↑↓: Select Item  
Enter: Select  
+/-: Change Opt.  
F1: General Help  
F2: Previous Values  
F3: Optimized Defaults  
F4: Save & Exit  
ESC: Exit

Version 2.18.1263. Copyright (C) 2020 American Megatrends, Inc.

## CPU Power Management

Aptio Setup Utility - Copyright (C) 2020 American Megatrends, Inc.

Advanced

**CPU Power Management Configuration**

EIST [Disabled]

Enable/Disable Intel SpeedStep

→←: Select Screen  
↑↓: Select Item  
Enter: Select  
+/-: Change Opt.  
F1: General Help  
F2: Previous Values  
F3: Optimized Defaults  
F4: Save & Exit  
ESC: Exit

Version 2.18.1263. Copyright (C) 2020 American Megatrends, Inc.

### EIST

Enables or disables Intel® SpeedStep.

## Network Stack Configuration

This section is used to configure the network stack settings.

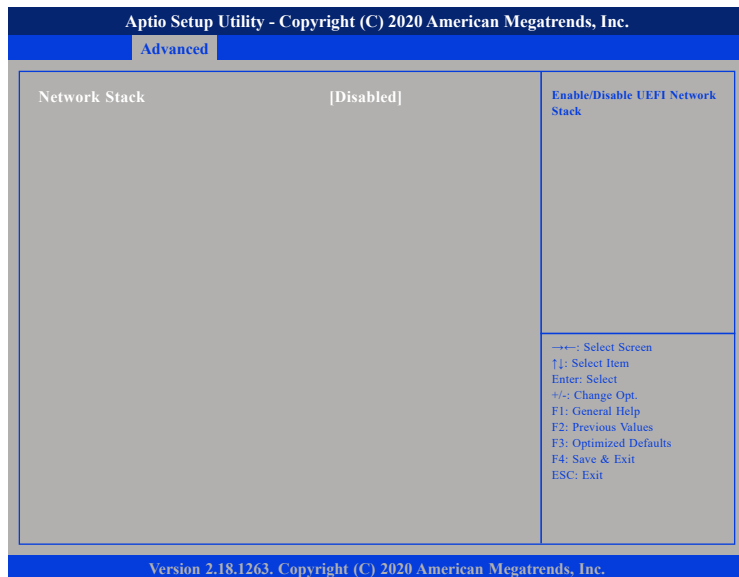

### Network Stack

Enables or disables UEFI network stack.

## Trusted Computing

This section is used to configure Trusted Platform Module (TPM) settings.



### Security Device Support

Enables or disables BIOS support for security device. O.S will not show Security Device. TCG EFI protocol and INT1A interface will not be available.

## USB Configuration

This section is used to configure the USB.



### XHCI Hand-off

This is a workaround for OSs that does not support XHCI hand-off. The XHCI ownership change should be claimed by the XHCI driver.

### USB Mass Storage Driver Support

Enables or disables USB mass storage driver support.

### USB transfer time-out

The time-out value for control, bulk, and Interrupt transfers.

### Device reset time-out

Selects the USB mass storage device's start unit command timeout.

### Device power-up delay

Maximum time the value will take before it properly reports itself to the Host Controller. "Auto" uses default value: for a Root port it is 100 ms, for a Hub port the delay is taken from Hub descriptor.

## Chipset

This section is used to configure the system based on the specific features of the chipset.



## South Bridge

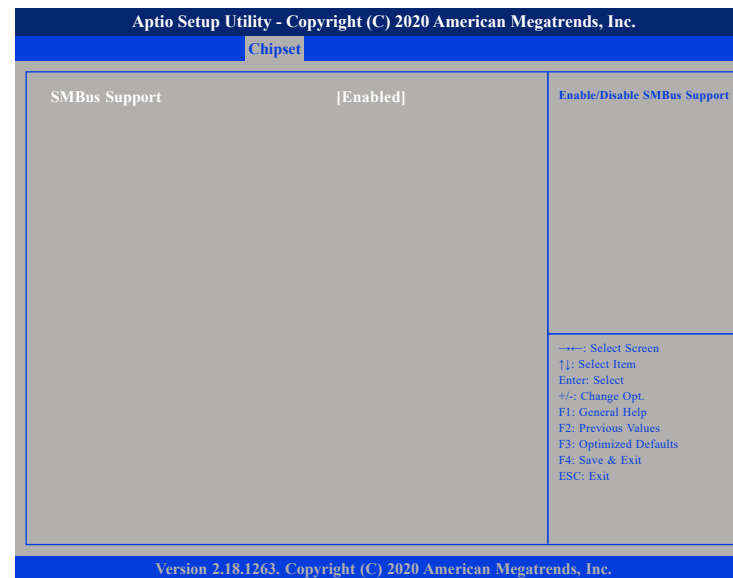

### SMBus Support

Enables or disables SMBus support.



Setting incorrect field values may cause the system to malfunction.

## South Cluster Configuration



## HD-Audio Configuration



### HD-Audio Support

Enables or disables HD Audio support.

## SATA Drives

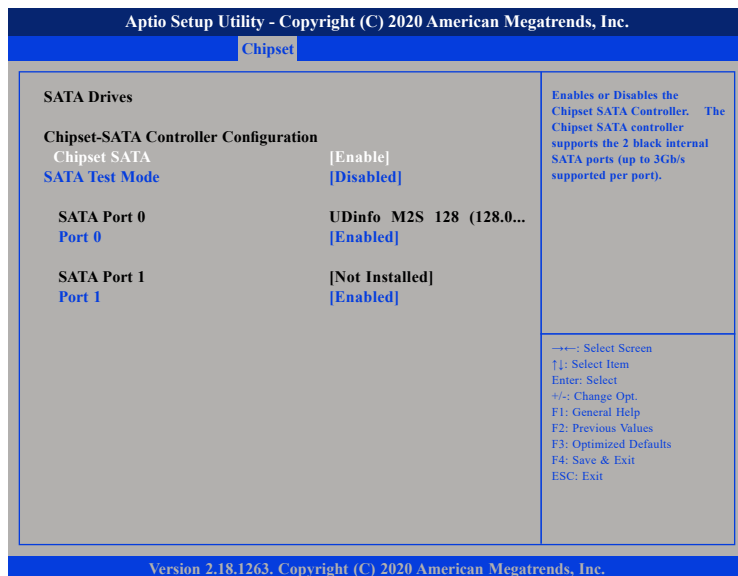

### Chipset SATA

Enables or disables the SATA controller chipset. The SATA controller chipset supports the 2 black internal SATA ports (up to 3Gb/s supported per port).

### SATA Test Mode

Enables or disables SATA test mode.

### Port 0

Enables or disables SATA port 0.

### Port 1

Enables or disables SATA port 1.

## USB Configuration

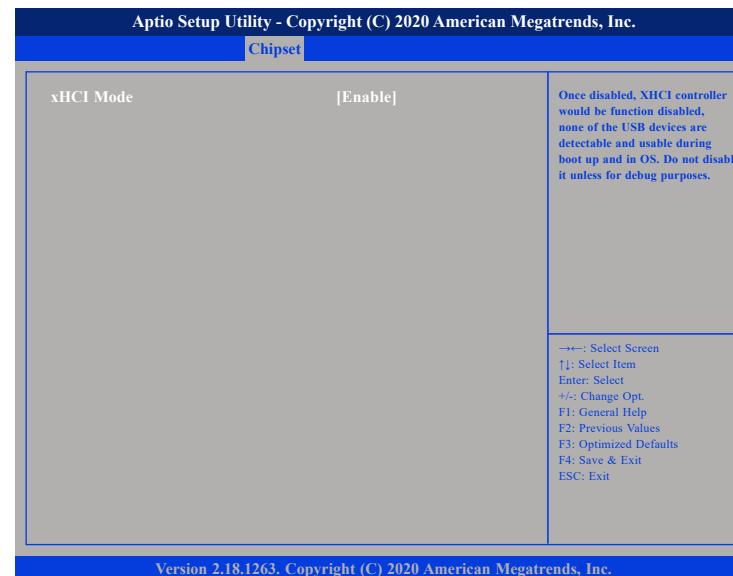

### xHCI Mode

Enables or disables xHCI mode. Once disabled, xHCI controller function will be disabled and all the USB devices will not be detectable and usable during boot up and in OS. Please do not disable it unless for debugging purposes.



## Miscellaneous Configuration



### High Precision Timer

Enables or disables high precision event timer.

### USB Power State in S5

Configures the USB power state in S5.

## Security

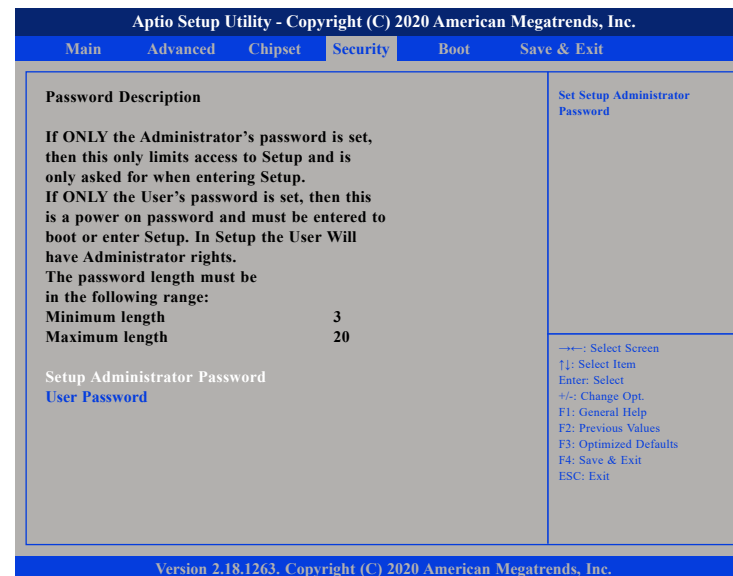

### Setup Administrator Password

Select this to reconfigure the administrator's password.

### User Password

Select this to reconfigure the user's password.

## Boot



### Bootup NumLock State

This allows you to determine the default state of the numeric keypad. By default, the system boots up with NumLock on wherein the function of the numeric keypad is the number keys. When set to Off, the function of the numeric keypad is the arrow keys

### Quiet Boot

Enabled Displays OEM logo instead of the POST messages.  
Disabled Displays normal POST messages.

### Boot Option Priorities

Adjust the boot sequence of the system. Boot Option #1 is the first boot device that the system will boot from, next will be #2 and so forth.

### Fast Boot

Enables or disables boot with initialization of a minimal set of devices required to launch active boot option. Has no effect for BBS boot options.

## Save & Exit



### Save Changes and Reset

To save the changes and reset, select this field then press <Enter>. A dialog box will appear. Confirm by selecting Yes.

### Discard Changes and Reset

To exit the Setup utility and reboot the system without saving the changes, select this field then press <Enter>. You may be prompted to confirm again before exiting.

### Restore Defaults

To restore the BIOS to default settings, select this field then press <Enter>. A dialog box will appear. Confirm by selecting Yes.