



**NEXCOM International Co., Ltd.**

# **Intelligent Platform & Services Business Unit**

## **Edge Computing System**

### **Neu-X303**

#### **User Manual**

# CONTENTS

## Preface

Copyright .....	iv
Disclaimer .....	iv
Acknowledgements .....	iv
Regulatory Compliance Statements .....	iv
Declaration of Conformity .....	iv
RoHS Compliance .....	v
Warranty and RMA .....	vi
Safety Information .....	viii
Installation Recommendations .....	viii
Safety Precautions .....	ix
Technical Support and Assistance .....	x
Conventions Used in this Manual .....	x
Global Service Contact Information .....	xi
Package Contents .....	xiii
Ordering Information .....	xiii

## Chapter 1: Product Introduction

Neu-X303 .....	1
Overview .....	1
Key Features .....	1
Hardware Specifications .....	2
Physical Features .....	4
Front Panel .....	4
Rear Panel .....	4
Mechanical Dimensions .....	5

## Chapter 2: Jumpers and Connectors

Before You Begin .....	6
Precautions .....	6
Jumper Settings .....	7
Locations of the Jumpers and Connectors .....	8
Top View .....	8
Bottom View .....	9
Jumpers .....	10
Coin Battery Discharge .....	10
Clear CMOS / ME .....	10
Connector Pin Definitions .....	11
Internal Connectors .....	11
RPMC Programming Header .....	11
BIOS Flash ROM Programming Header .....	11
PWR Button / Reset Button / HDD LED / PWR LED .....	12
CCG6DF Programming Header / I2C Debug .....	12
Battery Connector .....	13
Internal USB2.0 Header (2-port) .....	13
80 Debug Port Connector .....	14
COM Port Connector .....	14
FAN Connector .....	15
M.2 E-Key Connector (2230) .....	16
M.2 M-Key PCIe 4.0 Connector (2280) .....	17
External I/O Interfaces .....	18
DC Power Input Jack (+12V only) .....	18
LAN Connectors .....	19

USB3.2 2x2 + DP Type-C Connector .....	20
USB3.2 2x2 Type-A Connector .....	20
DP1.4 + HDMI 2.1 Connector .....	21
Block Diagram .....	22

## Chapter 3: System Setup

Installing a SO-DIMM Memory Module .....	23
Installing an M.2 M-Key SSD Module (M-Key 2280) .....	24
Installing a CPU.....	25
Installing a Wi-Fi Module .....	28

## Chapter 4: BIOS Setup

About BIOS Setup .....	30
When to Configure the BIOS.....	30
Default Configuration .....	31
Entering Setup .....	31
Legends .....	31
BIOS Setup Utility.....	33
Main .....	33
Advanced.....	34
Security .....	41
Boot.....	42
Save & Exit .....	43
MEBx ( iAMT) .....	44

## Appendix A: How to flash the BIOS

## Appendix B: Mounting the System

# PREFACE

## Copyright

This publication, including all photographs, illustrations and software, is protected under international copyright laws, with all rights reserved. No part of this manual may be reproduced, copied, translated or transmitted in any form or by any means without the prior written consent from Nexcobot Co., Ltd.

## Disclaimer

The information in this document is subject to change without prior notice and does not represent commitment from Nexcobot Co., Ltd. However, users may update their knowledge of any product in use by constantly checking its manual posted on our website: <http://www.nexcobot.com>. NexCOBOT shall not be liable for direct, indirect, special, incidental, or consequential damages arising out of the use of any product, nor for any infringements upon the rights of third parties, which may result from such use. Any implied warranties of merchantability or fitness for any particular purpose is also disclaimed.

## Acknowledgements

Neu-X303 is a trademark of Nexcobot Co., Ltd. All other product names mentioned herein are registered trademarks of their respective owners.

## Regulatory Compliance Statements

This section provides the FCC compliance statement for Class A devices and describes how to keep the system CE compliant.

## Declaration of Conformity

### FCC

This equipment has been tested and verified to comply with the limits for a Class A digital device, pursuant to Part 15 of FCC Rules. These limits are designed to provide reasonable protection against harmful interference when the equipment is operated in a commercial environment. This equipment generates, uses, and can radiate radio frequency energy and, if not installed and used in accordance with the instructions, may cause harmful interference to radio communications. Operation of this equipment in a residential area (domestic environment) is likely to cause harmful interference, in which case the user will be required to correct the interference (take adequate measures) at their own expense.

### CE

The product(s) described in this manual complies with all applicable European Union (CE) directives if it has a CE marking. For computer systems to remain CE compliant, only CE-compliant parts may be used. Maintaining CE compliance also requires proper cable and cabling techniques.

## RoHS Compliance



### NexCOBOT RoHS Environmental Policy and Status Update

NexCOBOT is a global citizen for building the digital infrastructure. We are committed to providing green products and services, which are compliant with European Union RoHS (Restriction on Use of Hazardous Substance in Electronic Equipment) directive 2011/65/EU, to be your trusted green partner and to protect our environment.

RoHS restricts the use of Lead (Pb) < 0.1% or 1,000ppm, Mercury (Hg) < 0.1% or 1,000ppm, Cadmium (Cd) < 0.01% or 100ppm, Hexavalent Chromium (Cr6+) < 0.1% or 1,000ppm, Polybrominated biphenyls (PBB) < 0.1% or 1,000ppm, and Polybrominated diphenyl Ethers (PBDE) < 0.1% or 1,000ppm.

In order to meet the RoHS compliant directives, NexCOBOT has established an engineering and manufacturing task force in to implement the introduction of green products. The task force will ensure that we follow the standard NexCOBOT development procedure and that all the new RoHS components and new manufacturing processes maintain the highest industry quality levels for which NexCOBOT are renowned.

The model selection criteria will be based on market demand. Vendors and suppliers will ensure that all designed components will be RoHS compliant.

### How to recognize NexCOBOT RoHS Products?

For existing products where there are non-RoHS and RoHS versions, the suffix "(LF)" will be added to the compliant product name.

All new product models launched after January 2013 will be RoHS compliant. They will use the usual NexCOBOT naming convention.

## Warranty and RMA

### NexCOBOT Warranty Period

NexCOBOT manufactures products that are new or equivalent to new in accordance with industry standard. NexCOBOT warrants that products will be free from defect in material and workmanship for 2 years, beginning on the date of invoice by NexCOBOT.

### NexCOBOT Return Merchandise Authorization (RMA)

- Customers shall enclose the “NexCOBOT RMA Service Form” with the returned packages.
- Customers must collect all the information about the problems encountered and note anything abnormal or, print out any on-screen messages, and describe the problems on the “NexCOBOT RMA Service Form” for the RMA number apply process.
- Customers can send back the faulty products with or without accessories (manuals, cable, etc.) and any components from the card, such as CPU and RAM. If the components were suspected as part of the problems, please note clearly which components are included. Otherwise, NexCOBOT is not responsible for the devices/parts.
- Customers are responsible for the safe packaging of defective products, making sure it is durable enough to be resistant against further damage and deterioration during transportation. In case of damages occurred during transportation, the repair is treated as “Out of Warranty.”
- Any products returned by NexCOBOT to other locations besides the customers’ site will bear an extra charge and will be billed to the customer.

### Repair Service Charges for Out-of-Warranty Products

NexCOBOT will charge for out-of-warranty products in two categories, one is basic diagnostic fee and another is component (product) fee.

#### System Level

- Component fee: NexCOBOT will only charge for main components such as SMD chip, BGA chip, etc. Passive components will be repaired for free, ex: resistor, capacitor.
- Items will be replaced with NexCOBOT products if the original one cannot be repaired. Ex: motherboard, power supply, etc.
- Replace with 3rd party products if needed.
- If RMA goods can not be repaired, NexCOBOT will return it to the customer without any charge.

#### Board Level

- Component fee: NexCOBOT will only charge for main components, such as SMD chip, BGA chip, etc. Passive components will be repaired for free, ex: resistors, capacitors.
- If RMA goods can not be repaired, NexCOBOT will return it to the customer without any charge.

## Warnings

Read and adhere to all warnings, cautions, and notices in this guide and the documentation supplied with the chassis, power supply, and accessory modules. If the instructions for the chassis and power supply are inconsistent with these instructions or the instructions for accessory modules, contact the supplier to find out how you can ensure that your computer meets safety and regulatory requirements.

## Cautions

Electrostatic discharge (ESD) can damage system components. Do the described procedures only at an ESD workstation. If no such station is available, you can provide some ESD protection by wearing an antistatic wrist strap and attaching it to a metal part of the computer chassis.

## Safety Information

Before installing and using the device, note the following precautions:

- Read all instructions carefully.
- Do not place the unit on an unstable surface, cart, or stand.
- Follow all warnings and cautions in this manual.
- When replacing parts, ensure that your service technician uses parts specified by the manufacturer.
- Avoid using the system near water, in direct sunlight, or near a heating device.
- The load of the system unit does not solely rely for support from the rackmounts located on the sides. Firm support from the bottom is highly necessary in order to provide balance stability.
- The computer is provided with a battery-powered real-time clock circuit. There is a danger of explosion if battery is incorrectly replaced. Replace only with the same or equivalent type recommended by the manufacturer. Discard used batteries according to the manufacturer's instructions.

### Cautions

RISK OF EXPLOSION IF BATTERY IS REPLACED BY AN INCORRECT TYPE  
DISPOSE OF USED BATTERIES ACCORDING TO THE INSTRUCTIONS.

## Installation Recommendations

Ensure you have a stable, clean working environment. Dust and dirt can get into components and cause a malfunction. Use containers to keep small components separated.

Adequate lighting and proper tools can prevent you from accidentally damaging the internal components. Most of the procedures that follow require only a few simple tools, including the following:

- A Philips screwdriver
- A flat-tipped screwdriver
- A grounding strap
- An anti-static pad

Using your fingers can disconnect most of the connections. It is recommended that you do not use needle-nose pliers to disconnect connections as these can damage the soft metal or plastic parts of the connectors.



## Safety Precautions

1. Read these safety instructions carefully.
2. Keep this User Manual for later reference.
3. Disconnect the equipment from any AC outlet before cleaning or installing a component inside the chassis. Use a damp cloth. Do not use liquid or spray detergents for cleaning.
4. To prevent electrostatic build-up, leave the board in its anti-static bag until you are ready to install it.
5. For plug-in equipment, the power outlet socket must be located near the equipment and must be easily accessible.
6. Keep the board away from humidity.
7. Put the board on a stable surface. Dropping it or letting it fall may cause damage.
8. Wear anti-static wrist strap.
9. Do all preparation work on a static-free surface.
10. Make sure the voltage of the power source is correct before connecting the equipment to the power outlet.
11. Hold the board only by its edges. Be careful not to touch any of the components, contacts or connections.
12. All cautions and warnings on the board should be noted.
13. Use the correct mounting screws and do not over tighten the screws.
14. Keep the original packaging and the anti-static bag; in case the board has to be returned for repair or replacement.

## Technical Support and Assistance

1. For the most updated information of NexCOBOT products, visit NexCOBOT's website at [www.nexcobot.com](http://www.nexcobot.com).
2. For technical issues that require contacting our technical support team or sales representative, please have the following information ready before calling:
  - Product name and serial number
  - Detailed information of the peripheral devices
  - Detailed information of the installed software (operating system, version, application software, etc.)
  - A complete description of the problem
  - The exact wordings of the error messages

### Warning!

1. Handling the unit: carry the unit with both hands and handle it with care.
2. Maintenance: to keep the unit clean, use only approved cleaning products or clean with a dry cloth.

## Conventions Used in this Manual



### Warning:

Information about certain situations, which if not observed, can cause personal injury. This will prevent injury to yourself when performing a task.



### Caution:

Information to avoid damaging components or losing data.



### Note:

Provides additional information to complete a task easily.

## Global Service Contact Information

### Headquarters

#### **NEXCOM International Co., Ltd.**

9F, No. 920, Zhongzheng Rd.,  
Zhonghe District, New Taipei City, 23586,  
Taiwan, R.O.C.  
Tel: +886-2-8226-7786  
Fax: +886-2-8226-7782  
www.nexcom.com

### Asia

#### **Taiwan**

#### **NexAIoT Headquarters**

#### **Industry 4.0 and Cloud Services**

12F, No.922, Zhongzheng Rd.,  
Zhonghe District, New Taipei City,  
23586, Taiwan, R.O.C.  
Tel: +886-2-8226-7796  
Fax: +886-2-8226-7926  
Email: sales@nexaiot.com  
www.nexaiot.com

#### **NexAIoT Co., Ltd.**

#### **Taichung Office**

16F, No.250, Sec.2, Chongde Rd.,  
Beitun District,  
Taichung City, 406, Taiwan, R.O.C.  
Tel: +886-4-2249-1179  
Fax: +886-4-2249-1172  
Email: jacobhuang@nexaiot.com  
www.nexaiot.com

#### **NexCOBOT Taiwan Co., Ltd.**

13F, No.916, Zhongzheng Rd.,  
Zhonghe District,  
New Taipei City, 23586, Taiwan, R.O.C.  
Tel: +886-2-8226-7786  
Fax: +886-2-8226-7926  
Email: jennyshern@nexcobot.com  
www.nexcobot.com

#### **GreenBase Technology Corp.**

13F, No.922, Zhongzheng Rd.,  
Zhonghe District,  
New Taipei City, 23586, Taiwan, R.O.C.  
Tel: +886-2-8226-7786  
Fax: +886-2-8226-7900  
Email: vivianlin@nexcom.com.tw  
www.nexcom.com.tw

#### **DivioTec Inc.**

19F-1A, No.97, Sec.4, ChongXin Rd.,  
Sanhong District,  
New Taipei City, 24161, Taiwan, R.O.C.  
Tel: +886-2-8976-3077  
Email: sales@diviotec.com  
www.diviotec.com

#### **AIoT Cloud Corp.**

13F, No.922, Zhongzheng Rd.,  
Zhonghe District,  
New Taipei City, 23586, Taiwan, R.O.C.  
Tel: +886-2-8226-7786  
Fax: +886-2-8226-7782  
Email: alantsai@aiotcloud.net  
www.aiotcloud.dev

#### **EMBUX TECHNOLOGY CO., LTD.**

13F, No.916, Zhongzheng Rd.,  
Zhonghe District,  
New Taipei City, 23586, Taiwan, R.O.C.  
Tel: +886-2-8226-7786  
Fax: +886-2-8226-7782  
Email: info@embux.com  
www.embux.com

#### **TMR TECHNOLOGIES CO., LTD.**

13F, No.916, Zhongzheng Rd.,  
Zhonghe District,  
New Taipei City, 23586, Taiwan, R.O.C.  
Tel: +886-2-8226-7786  
Fax: +886-2-8226-7782  
Email: services@tmrtek.com  
www.tmrtek.com

## China NEXSEC Incorporated

201, Floor 2, Unit 2, Building 15, Yard 3,  
Gaolizhang Road, Haidian District,  
Beijing, 100094, China  
Tel: +86-10-5704-2680  
Fax: +86-10-5704-2681  
Email: marketing@nexsec.cn  
www.nexsec.cn

## NEXCOM Shanghai

Room 406-407, Building C, No 154, Lane 953,  
Jianchuan Road, Minhang District,  
Shanghai, 201108, China  
Tel: +86-21-5278-5868  
Fax: +86-21-3251-6358  
Email: sales@nexcom.cn  
www.nexcom.cn

## NEXCOM Surveillance Technology Corp.

Floor 8, Building B3, Xiufeng Industrial Zone,  
GanKeng Community, Buji Street,  
LongGang District,  
ShenZhen, 518112, China  
Tel: +86-755-8364-7768  
Fax: +86-755-8364-7738  
Email: steveyang@nexcom.com.tw  
www.nexcom.cn

## NEXGOL Chongqing

1st Building No.999,  
Star Boulevard, Yongchuan Dist,  
Chongqing City, 402160, China  
Tel: +86-23-4960-9080  
Fax: +86-23-4966-5855  
Email: sales@nexgol.com.cn  
www.nexcom.cn

## Beijing NexGemo Technology Co.,Ltd.

Room 205, No.1, Fazhan Rd.,  
Beijing International Information Industry Base,  
Changping District,  
Beijing, 102206, China  
Tel: +86-10-8072-2025  
Fax: +86-10-8072-2022  
Email: sales@nexgemo.cn  
www.nexgemo.com

## Japan

### NEXCOM Japan

9F, Tamachi Hara Bldg.,  
4-11-5, Shiba Minato-ku,  
Tokyo, 108-0014, Japan  
Tel: +81-3-5419-7830  
Fax: +81-3-5419-7832  
Email: sales@nexcom-jp.com  
www.nexcom-jp.com

## America

### USA NEXCOM USA

46665 Fremont Blvd.,  
Fremont CA 94538, USA  
Tel: +1-510-656-2248  
Fax: +1-510-656-2158  
Email: sales@nexcom.com  
www.nexcomusa.com

## Package Contents

Before continuing, verify that the Neu-X303 package that you received is complete. Your package should have all the items listed in the following table.

Item	Part Number	Name	Qty
1	10W10X30301X0	Neu-X303	1
2	7400120033X00	(E)Power Adapter EDAC: EA11011H(T19) 120W 12V/10A w/lock	1
3	5060200703X00	THERMAL PAD T-GLOBAL 40x35x1.5mm K=12.5W/mk for CPU heatsink	1

## Ordering Information

The following below provides ordering information for Neu-X303.

### Neu-X303 (P/N: 10W10X30301X0)

12th generation Intel Core processor Edge Computing system

# CHAPTER 1: PRODUCT INTRODUCTION

## Neu-X303

### Overview



Front



Rear

### Key Features

- 12th Generation Intel® Core™ (Alder Lake - PS) processor SoC
- Four 4K@60Hz display output, DP, HDMI 2.1 and 2 x USB 3.2 Type-C
- Dual 2.5G LAN ports, 4 x USB 3.2 and 2 x USB 3.2 Type-C ports for easy connection
- Onboard M.2 2280 Key M with PCIe signal for storage modules
- Onboard M.2 2230 Key E for optional Wi-Fi modules
- Fanless and compact design (L:190mm, W:150mm, H:59.8mm)
- 12V DC in

## Hardware Specifications

### CPU Support

- Intel® Core Celeron/i3/i5/i7 LGA1700 PS socket type processor
  - CPU watts limits to 15W
  - Selected CPU models:
    - Intel® Core™ i7-1265UL, 10 Core, 1.8GHz, 12M Cache
    - Intel® Core™ i7-1255UL, 10 Core, 1.7GHz, 12M Cache
    - Intel® Core™ i5-1245UL, 10 Core, 1.6GHz, 12M Cache
    - Intel® Core™ i5-1235UL, 10 Core, 1.3GHz, 12M Cache
    - Intel® Core™ i3-1215UL, 6 Core, 1.2GHz, 10M Cache

### Graphics

- Intel® Iris Xe Graphics, driver compatible with DirectX 12 or later with WDDM 2.0 driver to support Windows 11

### Display

- 1 x DP1.4a connector, supports resolution up to 4096x2304@60Hz HDR
- 1 x HDMI 2.1 connector, supports resolution up to 7680x4320@60Hz HDR
  - Convert DP1.4a to HDMI 2.1 interface
- 2 x DP1.4a ports through USB Type C connector, supports resolution up to 3840x2160@60Hz HDR
  - The display interface of USB type C is TCP (USBC+DP)
  - USB type C PD controller: Cypress CCG6
  - Intel Burnside Bridge USB Type C Retimer (if needed)

### Main Memory

- 1 DPC, total 2 SO-DIMM socket
  - 2 x 262-pin SO-DIMM socket, support DDR5 (up to 4800MT/s) non-ECC memory
  - 8G~32GB.

### I/O Interface-Front

- Power Button with LED
- HDD LED

### I/O Interface-Rear

- 2 x Antenna hole for WiFi
- 4 x USB3.2 Gen 2x2 Type A (Support USB wake up)
- 2 x USB3.2 Gen 2x2 Type-C
  - 2x RJ45 Intel 2.5G Gigabit LAN support
- 1 x DP 1.4
- 1 x HDMI 2.1
- 1 x 12V DC jack with lock

### Internal I/O

- 1 x Fan connector (4-pin)
- 1 x USB 2.0 header (6-pin/2x ports)
- 1 x RS232 Header (9-pin)
- 1 x Battery connector (2-pin)
- 1 x eSPI Header: 10-pin header for I/O expansion.
- 1 x 2x5pin USBC PD programming header for firmware update
- 1 x Header (2x4 pin) for power, power LED, HDD LED, and reset
- 1 x 3-pin header for RTC normal operation or discharge
- 1 x CMOS/ME clear (1x3 pin) header
- 2 x SPI Programming header (2x4pin). 32MB BIOS & 4MB RPMC.
- 1 x on-board TPM2.0

### Storage

- 1 x M.2. 2280 Key M (PCIex4) storage and support NVME

## Network

- Intel FOXVILLE
- 2 x RJ45 connector with LEDs at back panel\*
  - 1 x RJ45 from Intel I225-LM GbE controller, support Intel® Active Management Technology 11.0
  - 1 x RJ45 from Intel® I225-V GbE controller
  - Support PXE LAN boot ROM for Ethernet Boot up
  - Support WOL



To fully support speeds of up to 2.5GbE, only CAT6A shielded cable is recommended.

## Power Supply

- 1 x External 12V/10A 120W DC input power adapter with lock

## Environment

- Operating Temperatures: @ 100% CPU loading and component thermal profile : 0~60 °C
- Storage Temperature: -40°C ~80°C
- Humidity: 95% (non-condensing)

## Dimensions

- 183mm (L) x 140mm (W) x 48mm (H)

## Operating System

- Windows 10 21H2
- Windows 11 21H2
- Linux 64-bit



# Physical Features

## Front Panel

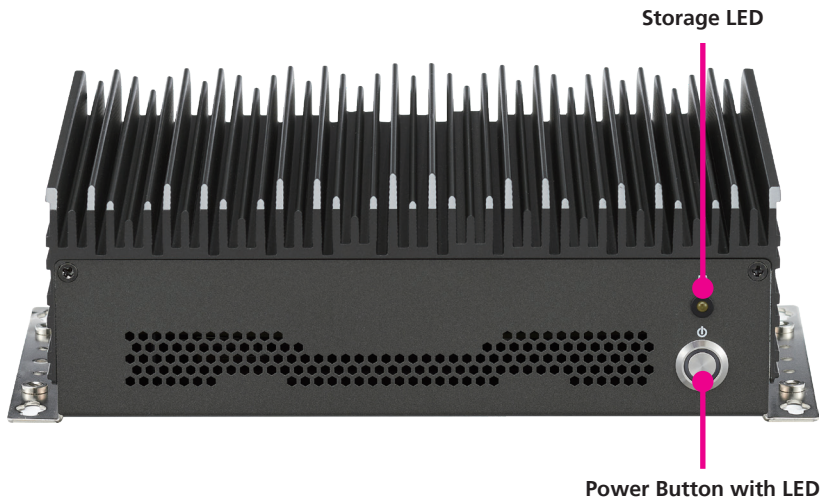

## Rear Panel

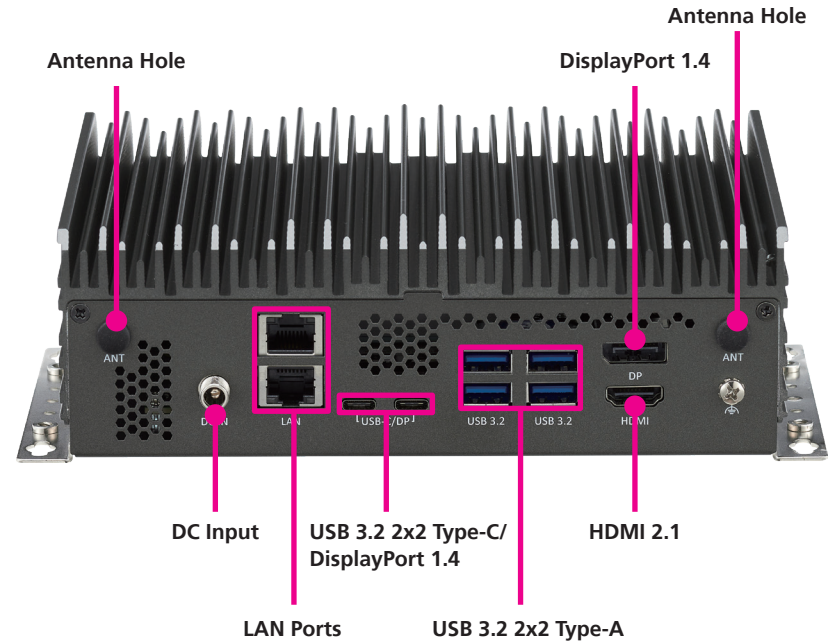

# Mechanical Dimensions

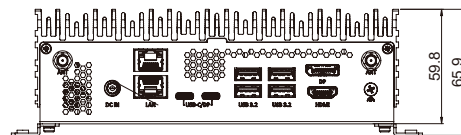
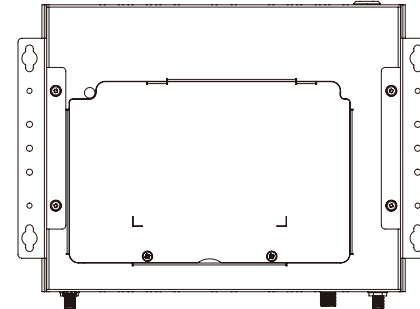
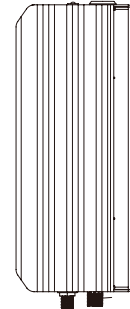
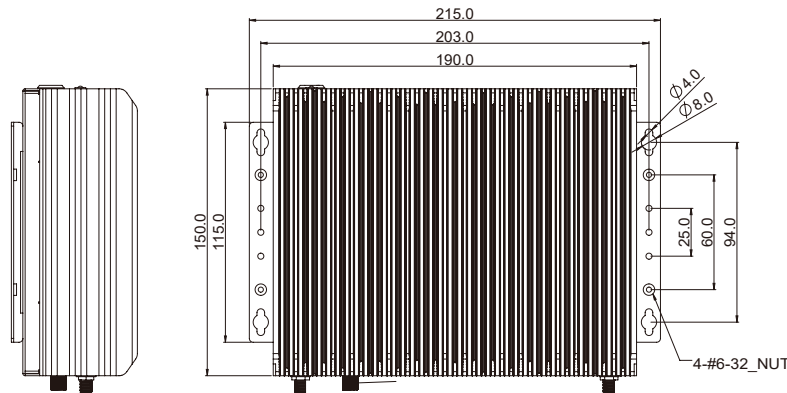
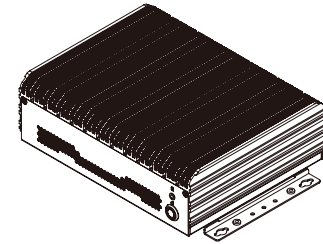
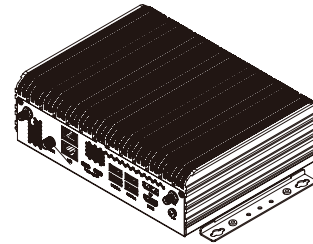
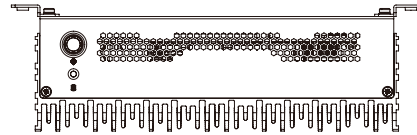

## CHAPTER 2: JUMPERS AND CONNECTORS

This chapter lists the locations of the jumpers and connectors for the Neu-X303.

### Before You Begin

- Ensure you have a stable, clean working environment. Dust and dirt can get into components and cause a malfunction. Use containers to keep small components separated.
- Adequate lighting and proper tools can prevent you from accidentally damaging the internal components. Most of the procedures that follow require only a few simple tools, including the following:
  - A Philips screwdriver
  - A flat-tipped screwdriver
  - A set of jewelers screwdrivers
  - A grounding strap
  - An anti-static pad
- Using your fingers can disconnect most of the connections. It is recommended that you do not use needle-nosed pliers to disconnect connections as these can damage the soft metal or plastic parts of the connectors.
- Before working on internal components, make sure that the power is off. Ground yourself before touching any internal components, by touching a metal object. Static electricity can damage many of the electronic components. Humid environments tend to have less static electricity than

dry environments. A grounding strap is warranted whenever danger of static electricity exists.

### Precautions

Computer components and electronic circuit boards can be damaged by discharges of static electricity. Working on computers that are still connected to a power supply can be extremely dangerous.

Follow the guidelines below to avoid damage to your computer or yourself:

- Always disconnect the unit from the power outlet whenever you are working inside the case.
- If possible, wear a grounded wrist strap when you are working inside the computer case. Alternatively, discharge any static electricity by touching the bare metal chassis of the unit case, or the bare metal body of any other grounded appliance.
- Hold electronic circuit boards by the edges only. Do not touch the components on the board unless it is necessary to do so. Don't flex or stress the circuit board.
- Leave all components inside the static-proof packaging that they shipped with until they are ready for installation.
- Use correct screws and do not over tighten screws.

## Jumper Settings

A jumper is the simplest kind of electric switch. It consists of two metal pins and a cap. When setting the jumpers, ensure that the jumper caps are placed on the correct pins. When the jumper cap is placed on both pins, the jumper is short. If you remove the jumper cap, or place the jumper cap on just one pin, the jumper is open.

Refer to the illustrations below for examples of what the 2-pin and 3-pin jumpers look like when they are short (on) and open (off).

Two-Pin Jumpers: Open (Left) and Short (Right)

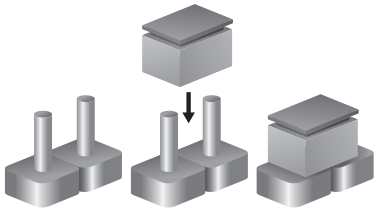

Three-Pin Jumpers: Pins 1 and 2 are Short

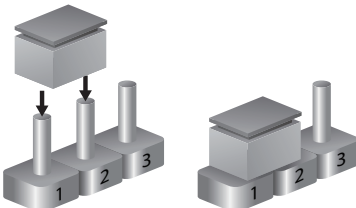

## Locations of the Jumpers and Connectors

The figures below show the location of the jumpers and connectors. Refer to this chapter for detailed pin settings and definitions of the connectors marked in pink on this figure.

### Top View

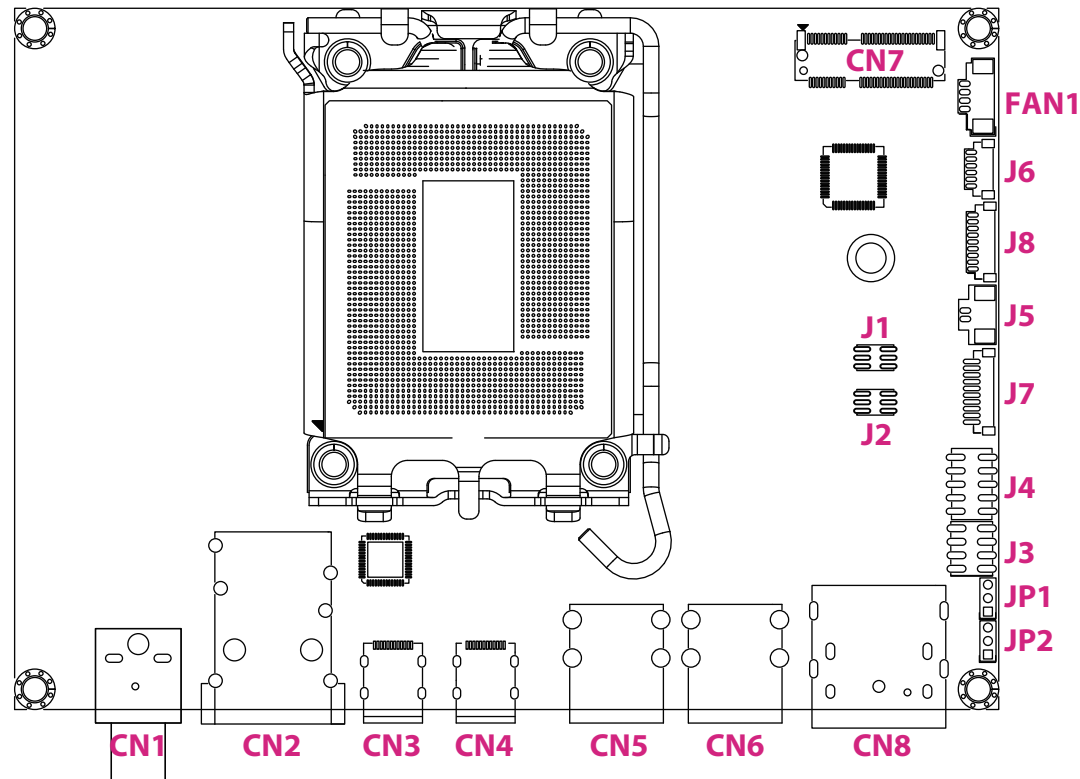

## Bottom View

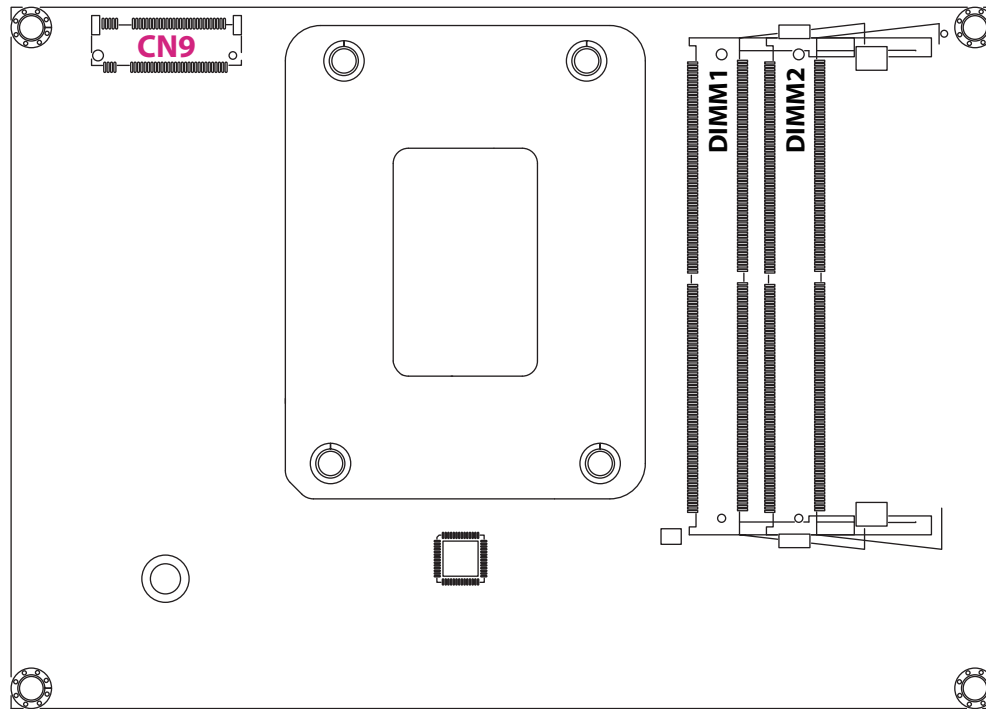

## Jumpers

### Coin Battery Discharge

Connector type: 1x3 3-pin header

Connector location: JP1

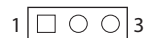

Pin	Definition
1-2	Normal operation
2-3	Discharge

1-2 On: default

### Clear CMOS / ME

Connector type: 1x3 3-pin header

Connector location: JP2



Pin	Definition
1-2	Clear ME Register
2-3	Clear CMOS

## Connector Pin Definitions

### Internal Connectors

#### RPMC Programming Header

Connector type: 2x3 6-pin header

Connector location: J1

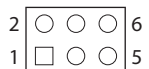

Pin	Definition	Pin	Definition
1	+1.8V	2	GND
3	SPIO_CS0_R_N	4	SPIO_CLK_FLASH0_R
5	SPIO_MISO_FLASH0_R	6	SPIO_MOSI_FLASH0_R

#### BIOS Flash ROM Programming Header

Connector type: 2x3 3-pin header

Connector location: J2

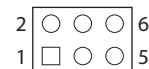

Pin	Definition	Pin	Definition
1	+1.8V	2	GND
3	SPIO_CS1_FLASH1_R_N	4	SPIO_CLK_FLASH1_R
5	SPIO_MISO_FLASH1_R	6	SPIO_MOSI_FLASH1_R



## PWR Button / Reset Button / HDD LED / PWR LED

Connector type: 2x4 8-pin header

Connector location: J3

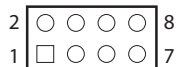

Pin	Definition	Pin	Definition
1	HDD_LED+	2	PWR_LED+
3	HDD_LED-	4	PWR_LED-
5	GND	6	Power On Button
7	RESET#	8	GND

## CCG6DF Programming Header / I2C Debug

Connector type: 2x5 10-pin header

Connector location: J4

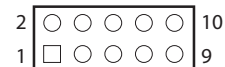

Pin	Definition	Pin	Definition
1	CCG6_I2C_SCL_SCB1	2	+VDDD_CCG6_TCP0
3	CCG6_I2C_SDA_SCB1	4	GND
5	GPPC_B11_PMC_ALERT_N	6	TCP0_CCG6_XRES_I
7	CCG6_I2C_SCL_SCB0	8	TCP0_CCG6_I2C_CFG
9	CCG6_I2C_SDA_SCB0	10	TCP0_CCG6_SWD_IO

## Battery Connector

Connector type: 1x2 2-pin header

Connector location: J5

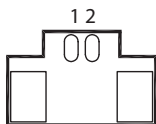

Pin	Definition
1	GND
2	BAT

## Internal USB2.0 Header (2-port)

Connector type: 1x6 6-pin header

Connector location: J6

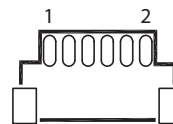

Pin	Definition
1	GND
2	USB2N
3	USB2P
4	USB1N
5	USB1P
6	+5V

## 80 Debug Port Connector

Connector type: 1x10 10-pin header

Connector location: J7

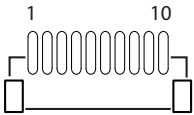

Pin	Definition	Pin	Definition
1	GND	2	PLTRST#
3	ESPI_CLK	4	ESPI_CS#
5	ESPI_IO3	6	ESPI_IO2
7	ESPI_IO2	8	ESPI_IO0
9	ESPI_RST#	10	+V3P3A

## COM Port Connector

Connector type: 1x9 9-pin header

Connector location: J8

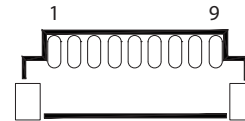

Pin	Definition
1	RI
2	CTS
3	RTS
4	DSR
5	GND
6	DTR
7	TXD
8	RXD
9	DCD

## FAN Connector

Connector type: 1x4 4-pin header

Connector location: FAN1

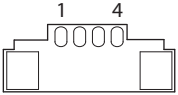

Pin	Definition
1	GND
2	+12V
3	FAN SPEED DETECT
4	FAN SPEED CONTROL

## M.2 E-Key Connector (2230)

Connector location: CN7

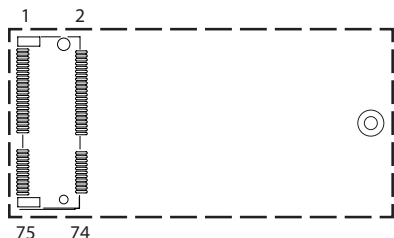

Pin	Definition	Pin	Definition
1	GND	2	3VSB
3	USBP	4	3VSB
5	USBN	6	LED1#
7	GND	8	NC
9	NC	10	NC
11	NC	12	NC
13	GND	14	NC
15	NC	16	LED2#
17	NC	18	GND
19	GND	20	NC
21	NC	22	NC
23	NC		
		32	NC
33	GND	34	NC
35	PCIE_TXP0	36	NC
37	PCIE_TXN0	38	CL_RST#
39	GND	40	CL_DAT
41	PCIE_RXP0	42	CL_CLK

Pin	Definition	Pin	Definition
43	PCIE_RXN0	44	NC
45	GND	46	NC
47	CLK_PCIEP0	48	NC
49	CLK_PCIEN0	50	SUSCLK
51	GND	52	PLTRST#
53	CLKREQ#	54	BT_DISABLE#
55	WAKE#	56	WIFI_DISABLE#
57	GND	58	NC
59	PCIE_TXP1	60	NC
61	PCIE_TXN1	62	NC
63	GND	64	NC
65	PCIE_RXP1	66	NC
67	PCIE_RXN1	68	NC
69	GND	70	NC
71	CLK_PCIEP1	72	3VSB
73	CLK_PCIEN1	74	3VSB
75	GND		

## M.2 M-Key PCIe 4.0 Connector (2280)

Connector location: CN9

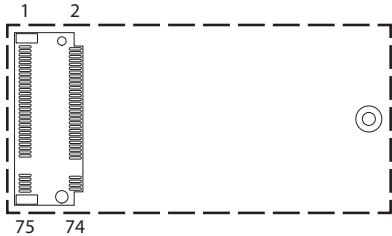

Pin	Definition	Pin	Definition
1	GND	2	+V3P3S
3	GND	4	+V3P3S
5	PCIE4_A_P3_M.2_SSD_RX_DN	6	NC
7	PCIE4_A_P3_M.2_SSD_RX_DP	8	NC
9	GND	10	M2M_DSS#
11	PCIE4_A_P3_M.2_SSD_TX_DN	12	+V3P3S
13	PCIE4_A_P3_M.2_SSD_TX_DP	14	+V3P3S
15	GND	16	+V3P3S
17	PCIE4_A_P2_M.2_SSD_RX_DN	18	+V3P3S
19	PCIE4_A_P2_M.2_SSD_RX_DP	20	NC
21	GND	22	NC
23	PCIE4_A_P2_M.2_SSD_TX_DN	24	NC
25	PCIE4_A_P2_M.2_SSD_TX_DP	26	NC
27	GND	28	NC
29	PCIE4_A_P1_M.2_SSD_RX_DN	30	NC
31	PCIE4_A_P1_M.2_SSD_RX_DP	32	NC
33	GND	34	NC
35	PCIE4_A_P1_M.2_SSD_TX_DN	36	NC
37	PCIE4_A_P1_M.2_SSD_TX_DP	38	NC

Pin	Definition	Pin	Definition
39	GND	40	NC
41	PCIE4_A_P0_M.2_SSD_RX_DN	42	NC
43	PCIE4_A_P0_M.2_SSD_RX_DP	44	NC
45	GND	46	NC
47	PCIE4_A_P0_M.2_SSD_TX_DN	48	NC
49	PCIE4_A_P0_M.2_SSD_TX_DP	50	RESET#
51	GND	52	CLKREQ#
53	CLK_SRC4_DN	54	WAKE#
55	CLK_SRC4_DP	56	NC
57	GND	58	NC
67	NC	68	NC
69	PCIE_M.2_CPU_SSD1_DETECT	70	+V3P3S
71	GND	72	+V3P3S
73	GND	74	+V3P3S
75	GND		

## External I/O Interfaces

### DC Power Input Jack (+12V only)

Connector type: 11 x 20.2 x 12.7mm 90D DIP 3P Center Pin 2.5mm  
12V/12.5A

Connector location: CN1

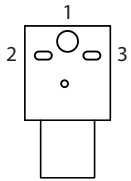

Pin	Definition
1	+12VSUS
2	GND
3	GND

## LAN Connectors

Connector type: RJ45 port with LEDs

Connector location: CN2

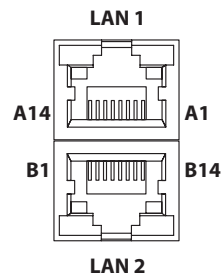
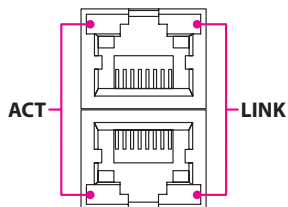

LAN Speed	Act. (Left)	Link (Right)
2.5G	Blinking Yellow	Steady Green
1G	Blinking Yellow	Steady Orange
10/100Mbps	Blinking Yellow	Off
No Active	Off	Off

LAN1		LAN2	
Pin	Definition	Pin	Definition
A1	MDI_OP_A	B1	MDI_OP_B
A2	MDI_ON_A	B2	MDI_ON_B
A3	MDI_1P_A	B3	MDI_1P_B
A4	MDI_1N_A	B4	MDI_1N_B
A5	MDI_2P_A	B5	MDI_2P_B
A6	MDI_2N_A	B6	MDI_2N_B
A7	MDI_3P_A	B7	MDI_3P_B
A8	MDI_3N_A	B8	MDI_3N_B
A9	CT_A	B9	CT_B
A10	GND	B10	GND
A11	+3V3_SB	B11	+3V3_SB
A12	ACTLED#_A	B12	ACTLED#_B
A13	LINK1000#_A	B13	LINK1000#_B
A14	LINK2500#_A	B14	LINK2500#_B



## USB3.2 2x2 + DP Type-C Connector

Connector type: USB 3.2 connectors, Type-C

Connector location: CN3, CN4

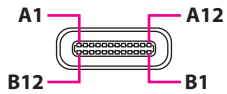

SBU1		SBU2	
Pin	Definition	Pin	Definition
A1	GND	B12	GND
A2	SSTX1+	B11	SSRX1+
A3	SSTX1-	B10	SSRX1-
A4	+5V	B9	+5V
A5	CC1	B8	SBU2
A6	D1+	B7	D2-
A7	D1-	B6	D2+
A8	SBU1	B5	CC2
A9	+5V	B4	+5V
A10	SSRX2-	B3	SSTX2-
A11	SSRX2+	B2	SSTX2+
A12	GND	B1	GND

## USB3.2 2x2 Type-A Connector

Connector type: USB 3.2 connectors, Type-A

Connector location: CN5, CN6

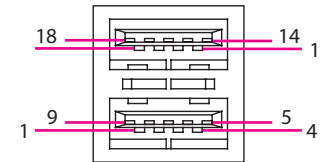

Pin	Definition	Pin	Definition
1	+5V	10	+5V
2	USB2_1N	11	USB2_2N
3	USB2_1P	12	USB2_2P
4	GND	13	GND
5	USB3_RX1N	14	USB3_RX2N
6	USB3_RX1P	15	USB3_RX2P
7	GND	16	GND
8	USB3_TX1N	17	USB3_TX2N
9	USB3_TX1P	18	USB3_TX2P

## DP1.4 + HDMI 2.1 Connector

Connector type: DisplayPort and HDMI connector

Connector location: CN8

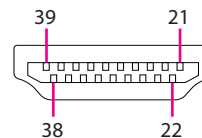
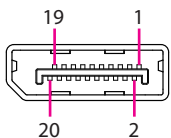

Pin	Definition	Pin	Definition
1	TX0P	11	GND
2	GND	12	TX3N
3	TX0N	13	CONFIG1
4	TX1P	14	CONFIG2
5	GND	15	AUXP
6	TX1N	16	GND
7	TX2P	17	AUXN
8	GND	18	HPD
9	TX2N	19	GND
10	TX3P	20	+3.3V

Pin	Definition	Pin	Definition
21	TX2P	31	GND
22	GND	32	CLKN
23	TX2N	33	CEC
24	TX1P	34	NC
25	GND	35	SCL
26	TX1N	36	SDA
27	TX0P	37	GND
28	GND	38	+5V
29	TX0N	39	HPD
30	CLKP		

# Block Diagram

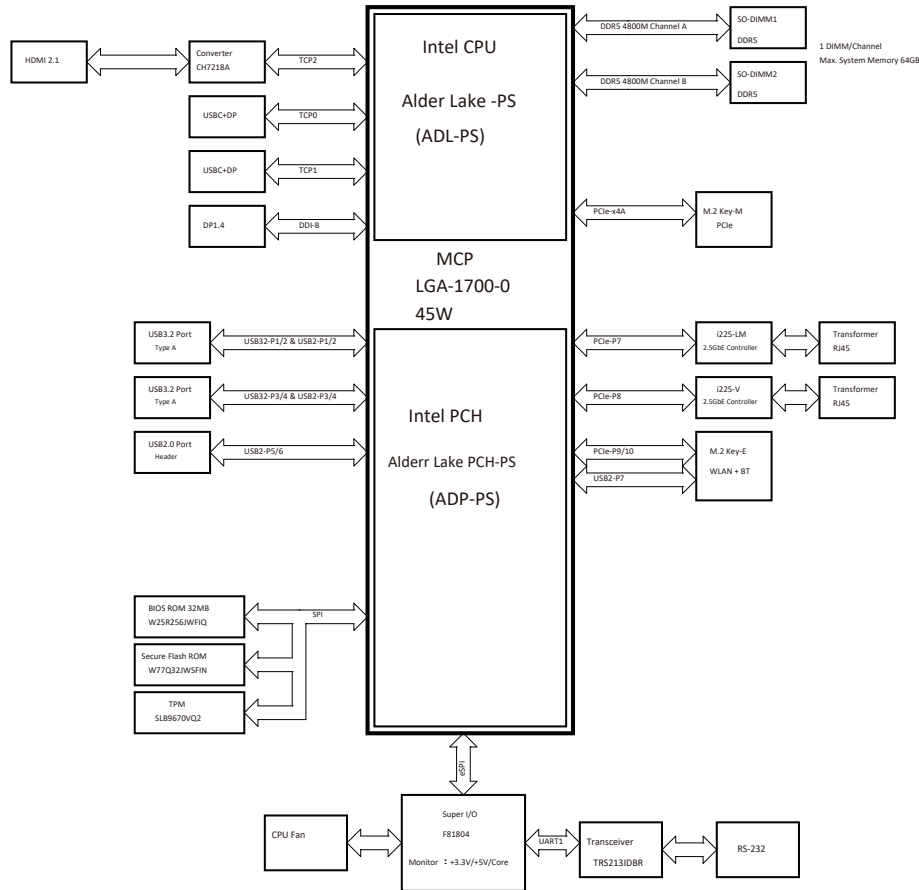

## CHAPTER 3: SYSTEM SETUP

### Installing a SO-DIMM Memory Module

1. Remove the cover from the chassis by loosening the screw on the bottom of the cover highlighted in the figure below.
2. With the bottom cover removed, install a memory module in the SO-DIMM socket. Insert the module into the socket at an approximately 30-degree angle. Push the module down until the clips on both sides of the socket lock into position. The gold-plated connector on the edge of the module will almost completely disappear inside the socket.

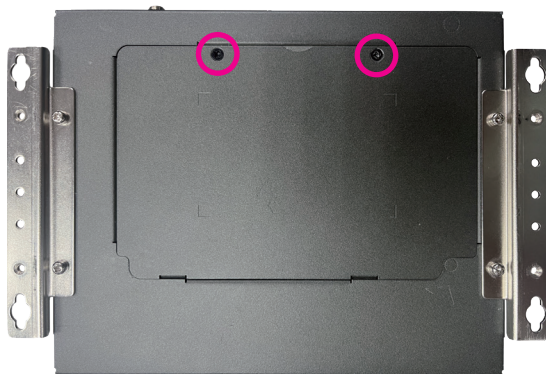

There is no particular order in which memory modules should be installed in the SO-DIMM slots. It's recommended that you install the same brand and speed of memory modules if you want to plug them into both of the slots.

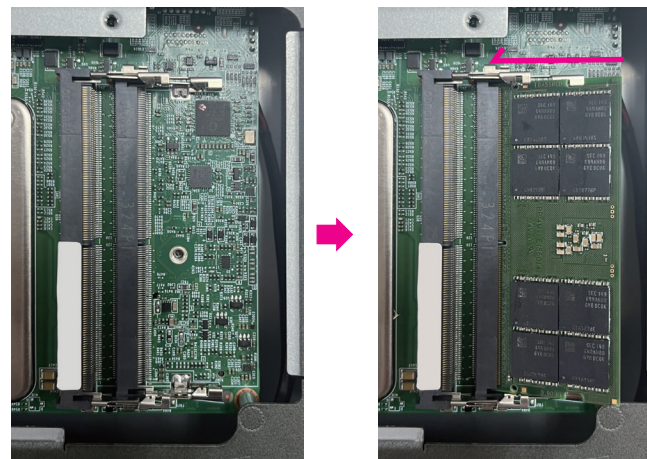

## Installing an M.2 M-Key SSD Module (M-Key 2280)

1. Remove the cover from the chassis by loosening the screw on the bottom of the cover highlighted in the figure below.
2. Insert the M.2 SSD module into the M.2 slot at a 45-degree angle until the gold-plated connector on the edge of the module completely disappears.
3. Once the module has been fully inserted, tighten the screw into the mounting hole to secure it in place.

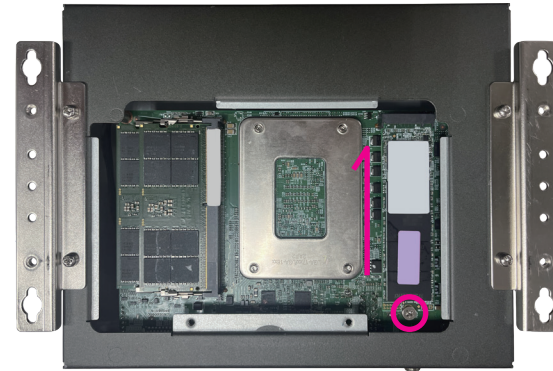
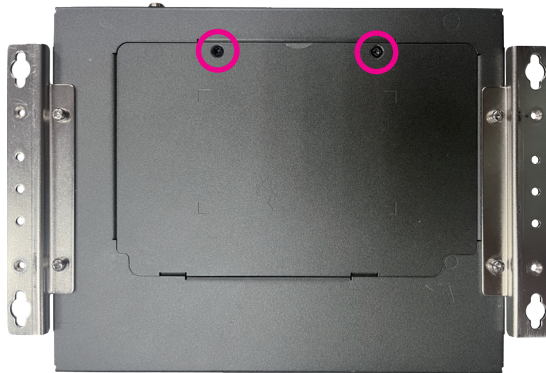

## Installing a CPU

1. Remove the cover from the chassis by loosening the screws highlighted in the images below.
2. Once the top cover has been removed, locate the CPU socket.

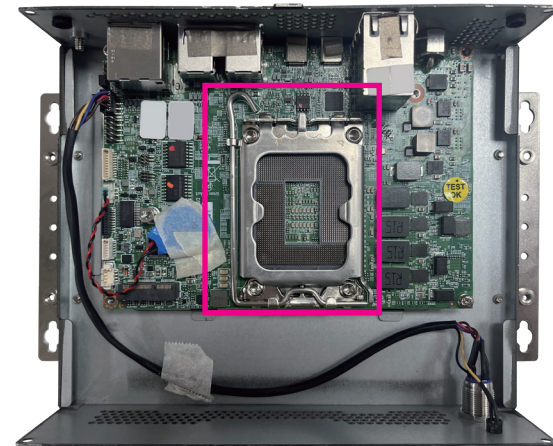

3. Unlock the socket by pushing the load lever down, moving it sideways until it is released from the retention tab; then lift the load lever up.

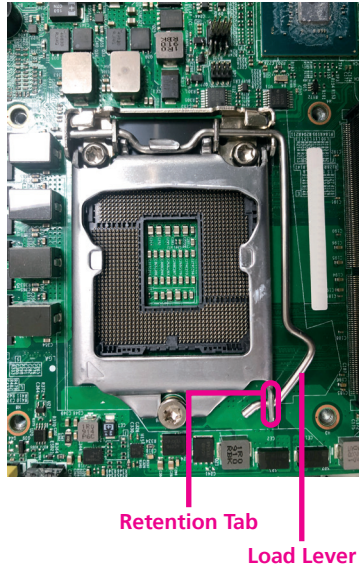

4. Insert the CPU into the socket. The triangular edge on the CPU must align with the corner of the CPU socket shown on the photo.

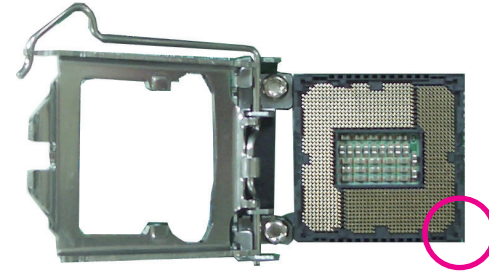

The CPU's notch will at the same time fit into the socket's alignment key.

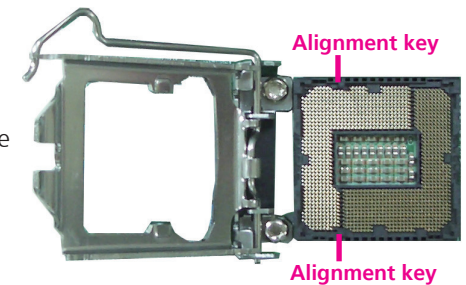

- Handle the CPU by its edges and avoid touching the pins.
- The CPU will fit in only one orientation and can easily be inserted without exerting any force.

5. Close the load plate and then hook the load lever under the retention tab.
6. Use the thermal pad to affix the CPU heatsink on the chassis and reinstall the chassis with the screws removed earlier (refer to [step 1](#)).

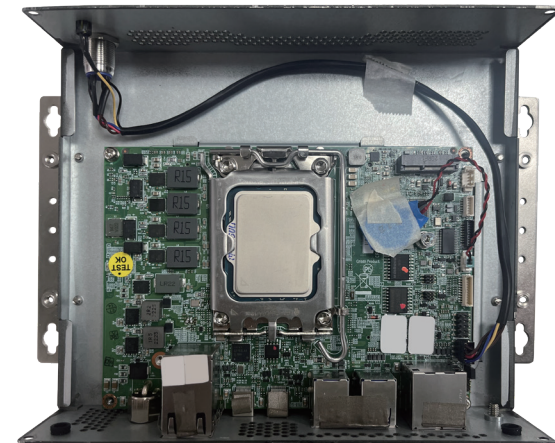
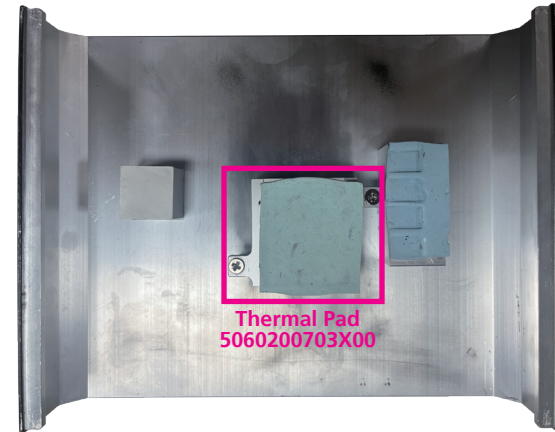

Do not force the CPU into the socket. Forcing the CPU into the socket may bend the pins and damage the CPU.



## Installing a Wi-Fi Module

1. Follow the [previous section](#) to remove the chassis and cooler module.
2. Insert the Wi-Fi module into the M.2 slot at a 45-degree angle until the gold-plated connector on the edge of the module completely disappears.
3. Push the Wi-Fi module down and fasten an M.2 mounting screw into the mounting hole to secure the module.

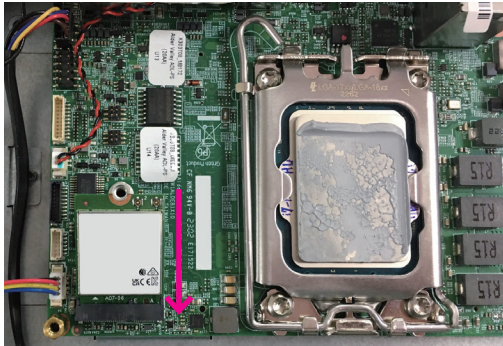

4. Connect the embedded antenna cables to the Wi-Fi module connectors highlighted in the figure below.

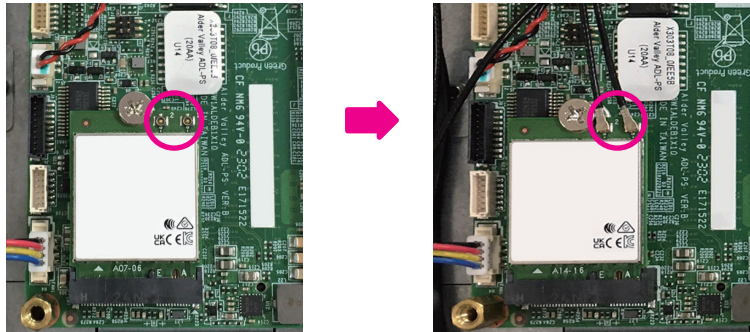

5. Once the Wi-Fi module is installed, place a thermal pad on the top of the Wi-Fi module.

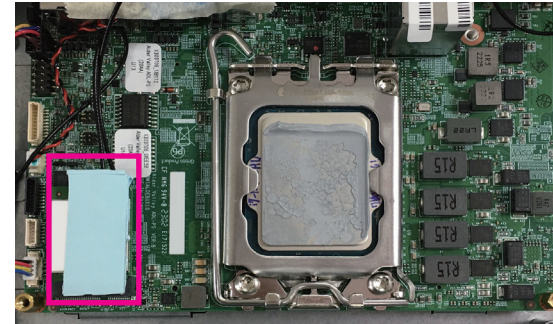

6. Following the previous disassembly steps, reassemble the cooler module and cover.

# CHAPTER 4: BIOS SETUP

This chapter describes how to use the BIOS setup program for the Neu-X300 series. The BIOS screens provided in this chapter are for reference only and may change if the BIOS is updated in the future.

To check for the latest updates and revisions, visit the NEXCOM website at [www.nexcom.com.tw](http://www.nexcom.com.tw).

## About BIOS Setup

The BIOS (Basic Input and Output System) Setup program is a menu driven utility that enables you to make changes to the system configuration and tailor your system to suit your individual work needs. It is a ROM-based configuration utility that displays the system's configuration status and provides you with a tool to set system parameters.

These parameters are stored in non-volatile battery-backed-up CMOS RAM that saves this information even when the power is turned off. When the system is turned back on, the system is configured with the values found in CMOS.

With easy-to-use pull down menus, you can configure such items as:

- Hard drives, diskette drives, and peripherals
- Video display type and display options
- Password protection from unauthorized use
- Power management features

The settings made in the setup program affect how the computer performs. It is important, therefore, first to try to understand all the setup options, and second, to make settings appropriate for the way you use the computer.

## When to Configure the BIOS

- This program should be executed under the following conditions:
  - When changing the system configuration
  - When a configuration error is detected by the system and you are prompted to make changes to the setup program
  - When resetting the system clock
  - When redefining the communication ports to prevent any conflicts
  - When making changes to the Power Management configuration
  - When changing the password or making other changes to the security setup

Normally, CMOS setup is needed when the system hardware is not consistent with the information contained in the CMOS RAM, whenever the CMOS RAM has lost power, or the system features need to be changed.

## Default Configuration

Most of the configuration settings are either predefined according to the Load Optimal Defaults settings which are stored in the BIOS or are automatically detected and configured without requiring any actions. There are a few settings that you may need to change depending on your system configuration.

## Entering Setup











When the system is powered on, the BIOS will enter the Power-On Self Test (POST) routines. These routines perform various diagnostic checks; if an error is encountered, the error will be reported in one of two different ways:

- If the error occurs before the display device is initialized, a series of beeps will be transmitted.
- If the error occurs after the display device is initialized, the screen will display the error message.

Powering on the computer and immediately pressing <Del> allows you to enter Setup.

Press the  key to enter Setup:

## Legends

Key	Function
	Moves the highlight left or right to select a menu.
	Moves the highlight up or down between sub-menus or fields.
	Exits the BIOS Setup Utility.
	Scrolls forward through the values or options of the highlighted field.
	Scrolls backward through the values or options of the highlighted field.
	Selects a field.
	Displays General Help.
	Load previous values.
	Load optimized default values.
	Saves and exits the Setup program.
	Press <Enter> to enter the highlighted sub-menu

## Scroll Bar

When a scroll bar appears to the right of the setup screen, it indicates that there are more available fields not shown on the screen. Use the up and down arrow keys to scroll through all the available fields.

## Submenu

When “▶” appears on the left of a particular field, it indicates that a submenu which contains additional options are available for that field. To display the submenu, move the highlight to that field and press  .

## BIOS Setup Utility

Once you enter the AMI BIOS Setup Utility, the Main Menu will appear on the screen. The main menu allows you to select from several setup functions and one exit. Use arrow keys to select among the items and press  to accept or enter the submenu.

### Main

The Main menu is the first screen that you will see when you enter the BIOS Setup Utility.

```

Aptio Setup - AMI
Main Advanced Security Boot Save & Exit MEBx(iAMT)
-----
| BIOS Information          ^ |
| BIOS Vendor              * | American Megatrends  * |
| Product Name             * | Neu-X303             * |
| Bios Version              * | 303Mini-004         * |
| Build Date and Time      * | 09/05/2023 11:48:24 * |
|                           * |                       * |
| Processor Information    * |                       * |
| Name                     * |                       * |
| Genuine Intel(R) 0000    * |                       * |
| ID                       * | 0x906A3              * |
| Microcode Revision       * | 416                  * |<: Select Screen
| Stepping                  * | L0                    * | ^v: Select Item
|                           * |                       * | +Enter: Select
| PCH Information          * | ++/-: Change Opt.   * |
| Name                     * | PCH-P                * | +F1: General Help
| PCH SKU                   * | ADL-PS SKU           * | +F2: Previous Values
|                           * |                       * | +F3: Optimized Defaults
| ME Information           * | v|F4: Save & Exit   * |
|                           * | |ESC: Exit          * |
|                           * |                       * |
-----
Version 2.22.1286 Copyright (C) 2023 AMI
  
```

## Advanced

The Advanced menu allows you to configure your system for basic operation. Some entries are defaults required by the system board, while others, if enabled, will improve the performance of your system or let you set some features according to your preference.



Setting incorrect field values may cause the system to malfunction.

### Wake on LAN Enable

Enable or disable integrated LAN to wake the system.

### State After G3

Configure the power state when power is re-applied after a power failure (G3 state)

```

Aptio Setup - AMI
Main  Advanced  Security  Boot  Save & Exit  MEBx(iAMT)
-----
| Wake on LAN Enable  [Enable]  |Enable/Disable
| State After G3     [S0 State] |integrated LAN to wake
|> CPU Configuration  |the system.
|> Trusted Computing
|> ACPI Settings
|> F81804 Super IO Configuration
|> Hardware Monitor
|> Network Stack Configuration
|> NVMe Configuration
|-----
|<>: Select Screen
|^v: Select Item
|Enter: Select
|+/-: Change Opt.
|F1: General Help
|F2: Previous Values
|F3: Optimized Defaults
|F4: Save & Exit
|ESC: Exit
|-----
Version 2.23.1286 Copyright (C) 2023 AMI
  
```

## CPU Configuration

This section is used to view CPU status and configure CPU parameters.

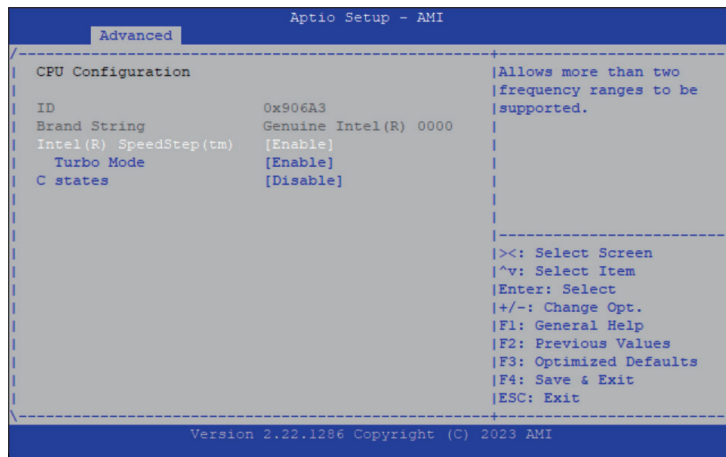

### Intel(R) SpeedStep(tm)

Enable or disable Intel Speedstep technology.

### Turbo Mode

Enable or disable turbo mode.

### C states

Enable or disables CPU to go to C states when it is not 100% utilized.

## Trusted Computing

This section is used to configure Trusted Platform Module (TPM) settings.

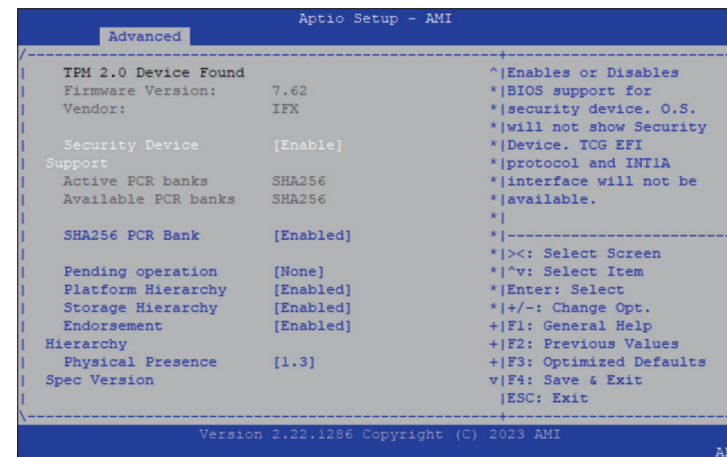

### Security Device Support

Enable or disable BIOS support for security device. O.S will not show Security Device. TCG EFI protocol and INT1A interface will not be available.

### SHA256 PCR Bank

Enable or disable SHA256 PCR Bank.

### Pending operation

Schedule an operation for the security device.



### Platform Hierarchy

Enable or disable platform hierarchy.

### Storage Hierarchy

Enable or disable storage hierarchy.

### Endorsement Hierarchy

Enable or disable endorsement hierarchy.

### Physical Presence Spec Version

Configure the physical presence spec version.

### ACPI Settings

This section is used to configure ACPI settings.

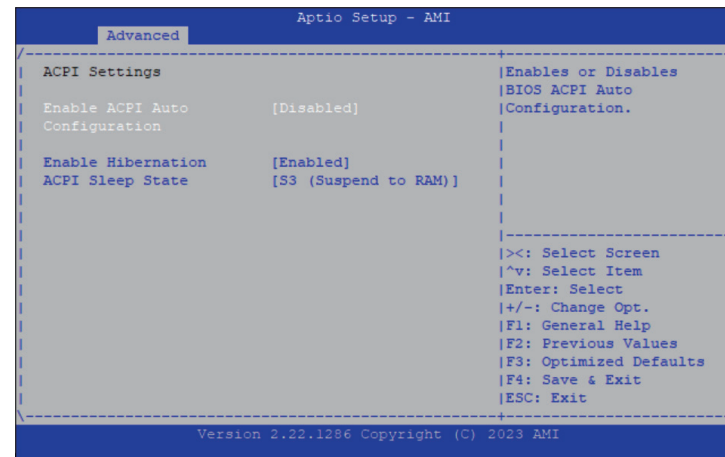

#### Enable ACPI Auto Configuration

Enable or disable BIOS ACPI Auto Configuration.

#### Enable Hibernation

Enable or disable system ability to hibernate (OS/S4 Sleep State). This option may not be effective with some operating systems.

#### ACPI Sleep State

Select the highest ACPI sleep state the system will enter when the suspend button is pressed. The options are Suspend Disabled and S3 (Suspend to RAM).

## F81804 Super IO Configuration

This section is used to configure the serial ports.

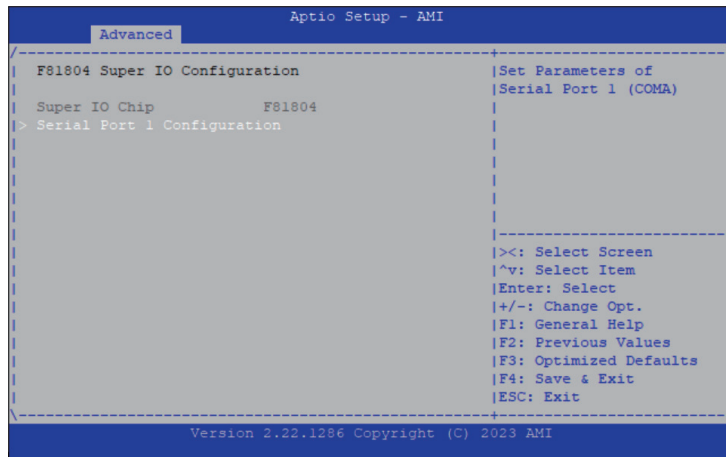

### Super IO Chip

Display the Super I/O chip used on the board.

### Serial Port 1 Configuration

Enter the submenu to set the parameters for serial port 1.

## Serial Port 1 Configuration

This section is used to configure serial port 1.

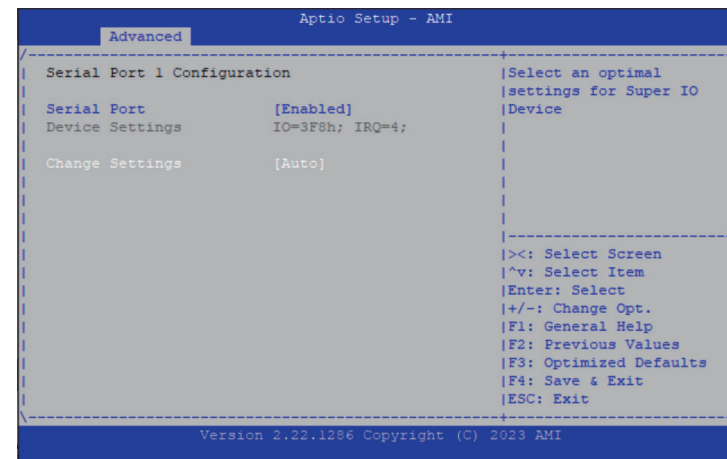

### Serial Port

Enable or disable serial port.

### Change Settings

Select an optimal setting for the Super IO device.

## Hardware Monitor

This section is used to monitor hardware status such as temperature, fan speed and voltages.

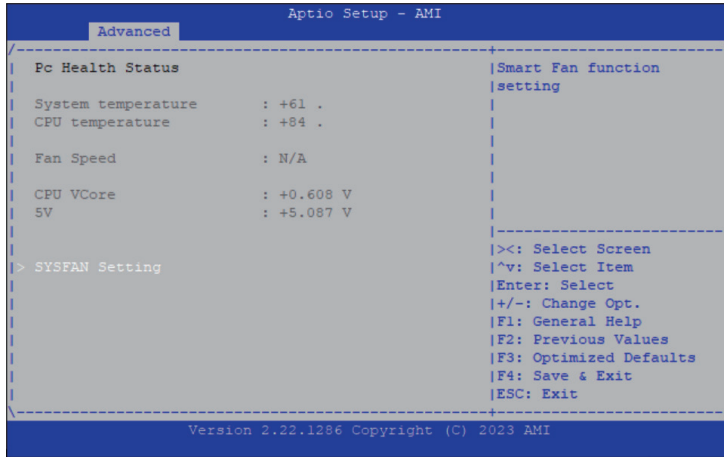

## SYSFAN Setting

Enter the SYSFAN Setting submenu.

## SYSFAN Setting

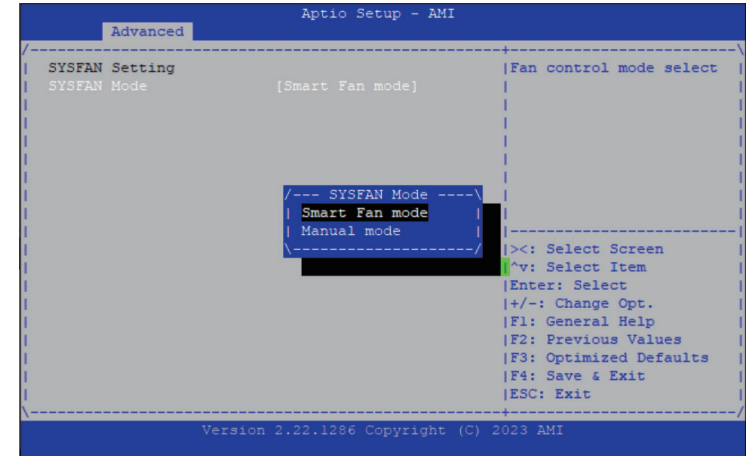

## SYSFAN Mode

Select a fan control mode.

## Network Stack Configuration

This section is used to configure the network stack.

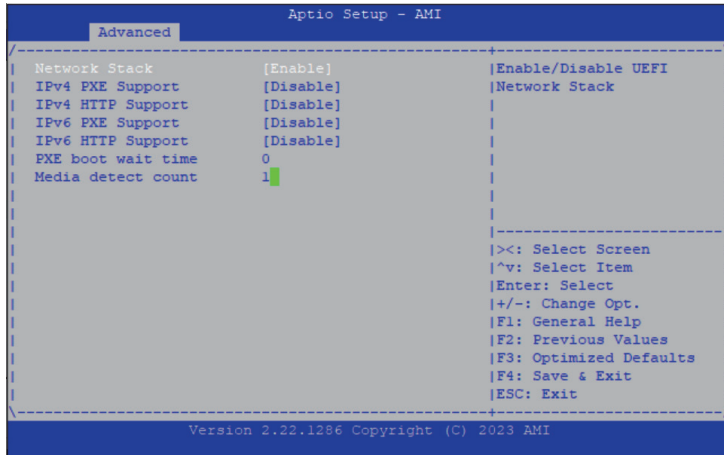

### Network Stack

Enable or disable UEFI network stack. Once enabled, more options are available for configuration.

### Ipv4 PXE Support

Enable or disable IPv4 PXE support. If disabled, the IPv4 boot option will not be created.

### Ipv4 HTTP Support

Enable or disable Ipv4 HTTP support.

### Ipv6 PXE Support

Enable or disable IPv6 PXE support. If disabled, the IPv6 boot option will not be created.

### Ipv6 HTTP Support

Enable or disable Ipv6 HTTP support.

### PXE boot wait time

Configure the wait time to press the ESC key to abort the PXE boot.

### Media detect count

Configure the number of times the media will be checked.

## NVMe Configuration

This section is used to configure the NVMe devices installed.

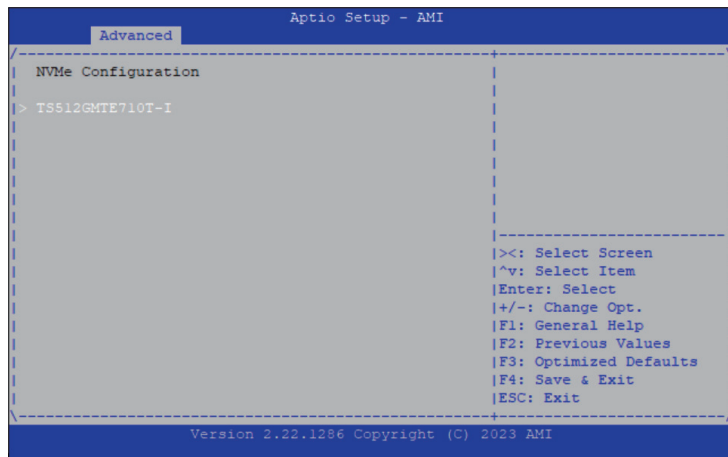

### NVMe Device

Enter NVMe device submenu.

### NVMe Device

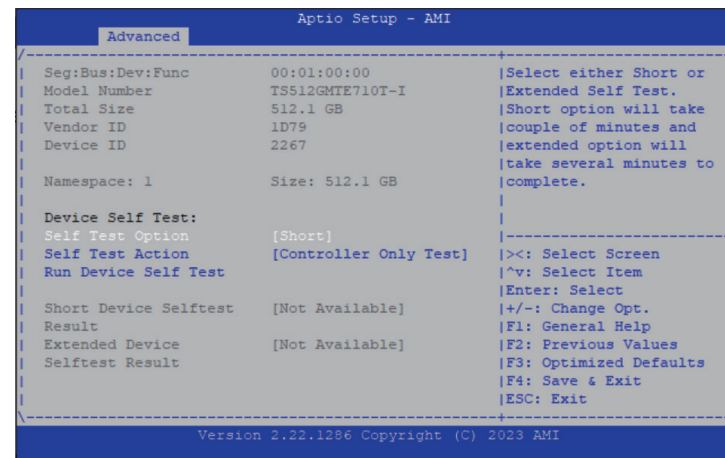

### Self Test Option

Configure the method used for self test. Short option will take couple of minutes to complete. Extended Extended option will take several minutes to complete.

### Self Test Action

Configure the items used for self test. Controller Only Test and Controller and NameSpace Test options are available. Selecting Controller and NameSpace Test will take longer to complete.

### Run Device Self Test

Run the device self test according to the self test option and action selected. Pressing the Esc key will abort the test.

## Security

```

Aptio Setup - AMI
Main Advanced Security Boot Save & Exit MEBx(iAMT)
-----
Password Description          |Set Administrator
                              |Password
If ONLY the Administrator's  |
password is set,              |
then this only limits access  |
to Setup and is only asked   |
for when entering Setup.     |
Administrator Password
> Secure Boot
                              |<: Select Screen
                              |^v: Select Item
                              |Enter: Select
                              |+/-: Change Opt.
                              |F1: General Help
                              |F2: Previous Values
                              |F3: Optimized Defaults
                              |F4: Save & Exit
                              |ESC: Exit
-----
Version 2.22.1286 Copyright (C) 2023 AMI

```

### Administrator Password

Set administrator's password.

### Secure Boot

Enter the Secure Boot submenu.

## Secure Boot

```

Aptio Setup - AMI
-----
Security
-----
System Mode          Setup
Secure Boot          [Enable]
                    Not Active
Secure Boot Mode     [Standard]
> Restore Factory Keys
> Reset To Setup Mode
> Key Management
                              |<: Select Screen
                              |^v: Select Item
                              |Enter: Select
                              |+/-: Change Opt.
                              |F1: General Help
                              |F2: Previous Values
                              |F3: Optimized Defaults
                              |F4: Save & Exit
                              |ESC: Exit
-----
Version 2.22.1286 Copyright (C) 2023 AMI
AB

```

### Secure Boot

Enable or disable the Secure Boot. Secure Boot only works when the system runs in user mode. The mode change requires platform reset.

### Secure Boot Mode

Select this to configure the Secure Boot mode.

Standard

Fixed scure boot policy.

Custom

Secure boot policy variables can be configured by a physically present user without full authentication.

## Boot

```

Main  Advanced  Security  Aptio Setup - AMI
                        Boot  Save & Exit  MEBx(iAMT)
-----
| Boot Configuration   | |Number of seconds to
| Setup Prompt Timeout| |wait for setup
|   [3]                | |
| Bootup NumLock State| |activation key.
|   [Off]              | |65535 (0xFFFF) means
| Quiet Boot          | |indefinite waiting.
|   [Enabled]          | |
|-----|-----|
| Boot Option Priorities
| Boot Option #1      | |
|   [ubuntu           | |
|   (TSS12GMIE710T-I)| |
| Boot Option #2      | |
|   [UEFI: ADATA USB  | |
|   Flash Drive 1.00, | |
|   Partition 1 (ADATA| |<: Select Screen
|   USB Flash Drive 1.00)]|^v: Select Item
| Boot Option #3      | |Enter: Select
|   [UEFI: Built-in EFI| |
|   Shell]            | |+/-: Change Opt.
| Fast Boot           | |F1: General Help
|   [Disabled]        | |F2: Previous Values
|                     | |F3: Optimized Defaults
|                     | |F4: Save & Exit
|                     | |ESC: Exit
|-----|-----|
| Version 2.22.1286 Copyright (C) 2023 AMI

```

### Setup Prompt Timeout

Number of seconds to wait for setup activation key. 65535 (0xFFFF) means indefinite waiting.

### Bootup NumLock State

This allows you to determine the default state of the numeric keypad. By default, the system boots up with NumLock on wherein the function of the numeric keypad is the number keys. When set to Off, the function of the numeric keypad is the arrow keys.

### Quiet Boot

Enabled            Display OEM logo instead of the POST messages.  
 Disabled          Display normal POST messages.

### Boot Option Priorities

Adjust the boot sequence of the system. Boot Option #1 is the first boot device that the system will boot from, next will be #2 and so forth.

### Fast Boot

When enabled, the BIOS will shorten or skip some check items during POST. This will decrease the time needed to boot the system.

## Save & Exit

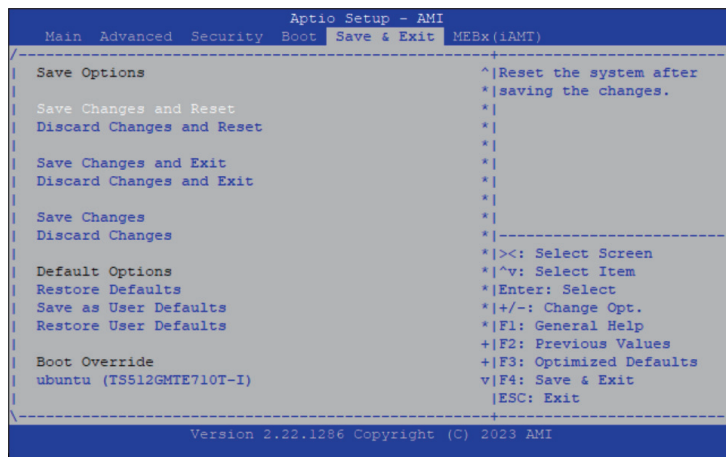

### Save Changes and Reset

To save the changes and reset, select this field then press <Enter>. A dialog box will appear. Confirm by selecting Yes.

### Discard Changes and Reset

To exit the Setup utility and reset without saving the changes, select this field then press <Enter>. You may be prompted to confirm again before exiting.

### Save Changes and Exit

To save the changes and exit the Setup utility, select this field then press <Enter>. A dialog box will appear. Confirm by selecting Yes. You can also press <F4> to save and exit Setup.

### Discard Changes and Exit

To exit the Setup utility without saving the changes, select this field then press <Enter>. You may be prompted to confirm again before exiting. You can also press <ESC> to exit without saving the changes.

### Save Changes

To save changes and continue configuring the BIOS, select this field then press <Enter>. A dialog box will appear. Confirm by selecting Yes.

### Discard Changes

To discard the changes, select this field then press <Enter>. A dialog box will appear. Confirm by selecting Yes to discard all changes made and restore the previously saved settings.

### Restore Defaults

To restore the BIOS to default settings, select this field then press <Enter>. A dialog box will appear. Confirm by selecting Yes.

### Save as User Defaults

To use the current configurations as user default settings for the BIOS, select this field then press <Enter>. A dialog box will appear. Confirm by selecting Yes.

### Restore User Defaults

To restore the BIOS to user default settings, select this field then press <Enter>. A dialog box will appear. Confirm by selecting Yes.

### Boot Override

To bypass the boot sequence from the Boot Option List and boot from a particular device, select the desired device and press <Enter>.



## MEBx ( iAMT)



### Intel(R) ME Password

Set a password for logging into MEBx.

# APPENDIX A: HOW TO FLASH THE BIOS

Before flashing the BIOS, prepare a USB flash drive and obtain the necessary update files. For more information of the files, please seek assistance from your local distributor.

1. Copy the update files to the USB flash drive. There should be a total of two files required for the update. The first file is X303C0X\_1 and the second file is X303C0X\_2. The "X" in the file name represents the BIOS version number, which may change with each new release.
2. Plug the USB flash drive you prepared into the system.
3. Power on the system and access the BIOS. To access the BIOS, refer to [Chapter 4](#).
4. Configure the BIOS to "[UEFI: Built-in EFI Shell](#)", then save the changes, exit, and reboot the system.
5. When the menu appears after system reboot, select "UEFI: Built-in EFI Shell".
6. The USB flash drive should be recognized, and then navigate to the directory of the USB flash drive.
7. Follow the on-screen instructions to flash the BIOS and ensure that you update the BIOS in the correct order of the file names, X303C0X\_1 and X303C0X\_2.
8. Once the update is completed, disable the UEFI Shell in the BIOS, save the changes, and reboot the system.

## APPENDIX B: MOUNTING THE SYSTEM

This system supports wall mount installation. Please follow the steps outlined below to complete the installation.

1. Turn the system to its backside.
2. Secure the wall mount brackets using P head M3 6L screws (Q'ty: 4 pcs) in the positions indicated below.
3. Once the brackets are installed, secure the system to the wall by fastening screws through the mounting holes of the brackets, as indicated in the illustration below. The recommended screw type is #6-32, L defined by user (Q'ty: 4 pcs).

