



NexCOBOT Co., Ltd.

Intelligent Platform & Services Business Unit
Embedded Computing (Industrial Motherboard)
NEX 818
User Manual

CONTENTS

Preface

Copyright	iv
Disclaimer	iv
Acknowledgements	iv
Regulatory Compliance Statements	iv
Declaration of Conformity	iv
RoHS Compliance	v
Warranty and RMA	vi
Safety Information	viii
Installation Recommendations	viii
Safety Precautions	ix
Technical Support and Assistance	x
Conventions Used in this Manual	x
Global Service Contact Information	xi
Package Contents	xiii
Ordering Information	xiv

Chapter 1: Product Introduction

Overview	1
Key Features	1
Hardware Specifications	2
Knowing Your NEX 818	4
Edge I/O View	5

Chapter 2: Jumpers and Connectors

Before You Begin	6
Precautions	6
Jumper Settings	7
Locations of the Jumpers and Connectors	8
Jumpers	9
AT/ATX Mode Selection	9
LVDS Panel Power Selection	9
Chassis Intrusion	10
RTC RAM Clear	10
COM1 Ring/+5V/+12V Selection	11
Intel® ME (Management Engine) Selection	11
COM1 RS-422/485 Terminator Selection	12
eDP/LVDS T-con IC Power Selection	12
Internal Connector Pin Definitions	13
Front Panel Audio Header	13
Audio Amplifier Header	13
Battery Connector	14
CPU Fan and Chassis Fan Headers	14
Serial Port	15
Serial Port Headers	15
Debug Card Connector	18
Digital I/O Header	18



24-pin ATX Power Connector	19
8-pin ATX Power Connector	19
eDP/LVDS Connector	20
Front/System Panel Header	21
LVDS Panel Backlight Power Header.....	21
Serial ATA 6.0Gb/s Connectors	22
BIOS Programmable Header.....	22
USB 2.0 Header	23
USB 3.2 Gen 1 Header.....	23
LED Indicators	24
LAN 1/2 Ports LEDs.....	24
Standby Power LEDs.....	25
Block Diagram	26

Chapter 3: BIOS Setup

About BIOS Setup.....	27
When to Configure the BIOS.....	27
Default Configuration	28
Entering Setup	28
Legends	28
BIOS Setup Utility.....	30
Main	30
Advanced.....	30
Chipset Menu.....	40
Security	41
Boot.....	42
Save & Exit	43
MEBx.....	43

PREFACE

Copyright

This publication, including all photographs, illustrations and software, is protected under international copyright laws, with all rights reserved. No part of this manual may be reproduced, copied, translated or transmitted in any form or by any means without the prior written consent from Nexcobot Co., Ltd.

Disclaimer

The information in this document is subject to change without prior notice and does not represent commitment from Nexcobot Co., Ltd. However, users may update their knowledge of any product in use by constantly checking its manual posted on our website: <http://www.nexcobot.com>. NexCOBOT shall not be liable for direct, indirect, special, incidental, or consequential damages arising out of the use of any product, nor for any infringements upon the rights of third parties, which may result from such use. Any implied warranties of merchantability or fitness for any particular purpose is also disclaimed.

Acknowledgements

NEX 818 is a trademark of Nexcobot Co., Ltd. All other product names mentioned herein are registered trademarks of their respective owners.

Regulatory Compliance Statements

This section provides the FCC compliance statement for Class A devices and describes how to keep the system CE compliant.

Declaration of Conformity

FCC

This equipment has been tested and verified to comply with the limits for a Class A digital device, pursuant to Part 15 of FCC Rules. These limits are designed to provide reasonable protection against harmful interference when the equipment is operated in a commercial environment. This equipment generates, uses, and can radiate radio frequency energy and, if not installed and used in accordance with the instructions, may cause harmful interference to radio communications. Operation of this equipment in a residential area (domestic environment) is likely to cause harmful interference, in which case the user will be required to correct the interference (take adequate measures) at their own expense.

CE

The product(s) described in this manual complies with all applicable European Union (CE) directives if it has a CE marking. For computer systems to remain CE compliant, only CE-compliant parts may be used. Maintaining CE compliance also requires proper cable and cabling techniques.

RoHS Compliance



NexCOBOT RoHS Environmental Policy and Status Update

NexCOBOT is a global citizen for building the digital infrastructure. We are committed to providing green products and services, which are compliant with European Union RoHS (Restriction on Use of Hazardous Substance in Electronic Equipment) directive 2011/65/EU, to be your trusted green partner and to protect our environment.

RoHS restricts the use of Lead (Pb) < 0.1% or 1,000ppm, Mercury (Hg) < 0.1% or 1,000ppm, Cadmium (Cd) < 0.01% or 100ppm, Hexavalent Chromium (Cr6+) < 0.1% or 1,000ppm, Polybrominated biphenyls (PBB) < 0.1% or 1,000ppm, and Polybrominated diphenyl Ethers (PBDE) < 0.1% or 1,000ppm.

In order to meet the RoHS compliant directives, NexCOBOT has established an engineering and manufacturing task force in to implement the introduction of green products. The task force will ensure that we follow the standard NexCOBOT development procedure and that all the new RoHS components and new manufacturing processes maintain the highest industry quality levels for which NexCOBOT are renowned.

The model selection criteria will be based on market demand. Vendors and suppliers will ensure that all designed components will be RoHS compliant.

How to recognize NexCOBOT RoHS Products?

For existing products where there are non-RoHS and RoHS versions, the suffix "(LF)" will be added to the compliant product name.

All new product models launched after January 2013 will be RoHS compliant. They will use the usual NexCOBOT naming convention.

Warranty and RMA

NexCOBOT Warranty Period

NexCOBOT manufactures products that are new or equivalent to new in accordance with industry standard. NexCOBOT warrants that products will be free from defect in material and workmanship for 2 years, beginning on the date of invoice by NexCOBOT.

NexCOBOT Return Merchandise Authorization (RMA)

- Customers shall enclose the “NexCOBOT RMA Service Form” with the returned packages.
- Customers must collect all the information about the problems encountered and note anything abnormal or, print out any on-screen messages, and describe the problems on the “NexCOBOT RMA Service Form” for the RMA number apply process.
- Customers can send back the faulty products with or without accessories (manuals, cable, etc.) and any components from the card, such as CPU and RAM. If the components were suspected as part of the problems, please note clearly which components are included. Otherwise, NexCOBOT is not responsible for the devices/parts.
- Customers are responsible for the safe packaging of defective products, making sure it is durable enough to be resistant against further damage and deterioration during transportation. In case of damages occurred during transportation, the repair is treated as “Out of Warranty.”
- Any products returned by NexCOBOT to other locations besides the customers’ site will bear an extra charge and will be billed to the customer.

Repair Service Charges for Out-of-Warranty Products

NexCOBOT will charge for out-of-warranty products in two categories, one is basic diagnostic fee and another is component (product) fee.

System Level

- Component fee: NexCOBOT will only charge for main components such as SMD chip, BGA chip, etc. Passive components will be repaired for free, ex: resistor, capacitor.
- Items will be replaced with NexCOBOT products if the original one cannot be repaired. Ex: motherboard, power supply, etc.
- Replace with 3rd party products if needed.
- If RMA goods can not be repaired, NexCOBOT will return it to the customer without any charge.

Board Level

- Component fee: NexCOBOT will only charge for main components, such as SMD chip, BGA chip, etc. Passive components will be repaired for free, ex: resistors, capacitors.
- If RMA goods can not be repaired, NexCOBOT will return it to the customer without any charge.

Warnings

Read and adhere to all warnings, cautions, and notices in this guide and the documentation supplied with the chassis, power supply, and accessory modules. If the instructions for the chassis and power supply are inconsistent with these instructions or the instructions for accessory modules, contact the supplier to find out how you can ensure that your computer meets safety and regulatory requirements.

Cautions

Electrostatic discharge (ESD) can damage system components. Do the described procedures only at an ESD workstation. If no such station is available, you can provide some ESD protection by wearing an antistatic wrist strap and attaching it to a metal part of the computer chassis.

Safety Information

Before installing and using the device, note the following precautions:

- Read all instructions carefully.
- Do not place the unit on an unstable surface, cart, or stand.
- Follow all warnings and cautions in this manual.
- When replacing parts, ensure that your service technician uses parts specified by the manufacturer.
- Avoid using the system near water, in direct sunlight, or near a heating device.
- The load of the system unit does not solely rely for support from the rackmounts located on the sides. Firm support from the bottom is highly necessary in order to provide balance stability.
- The computer is provided with a battery-powered real-time clock circuit. There is a danger of explosion if battery is incorrectly replaced. Replace only with the same or equivalent type recommended by the manufacturer. Discard used batteries according to the manufacturer's instructions.

Installation Recommendations

Ensure you have a stable, clean working environment. Dust and dirt can get into components and cause a malfunction. Use containers to keep small components separated.

Adequate lighting and proper tools can prevent you from accidentally damaging the internal components. Most of the procedures that follow require only a few simple tools, including the following:

- A Philips screwdriver
- A flat-tipped screwdriver
- A grounding strap
- An anti-static pad

Using your fingers can disconnect most of the connections. It is recommended that you do not use needle-nose pliers to disconnect connections as these can damage the soft metal or plastic parts of the connectors.

Safety Precautions

1. Read these safety instructions carefully.
2. Keep this User Manual for later reference.
3. Disconnect the equipment from any AC outlet before cleaning or installing a component inside the chassis. Use a damp cloth. Do not use liquid or spray detergents for cleaning.
4. To prevent electrostatic build-up, leave the board in its anti-static bag until you are ready to install it.
5. For plug-in equipment, the power outlet socket must be located near the equipment and must be easily accessible.
6. Keep the board away from humidity.
7. Put the board on a stable surface. Dropping it or letting it fall may cause damage.
8. Wear anti-static wrist strap.
9. Do all preparation work on a static-free surface.
10. Make sure the voltage of the power source is correct before connecting the equipment to the power outlet.
11. Hold the board only by its edges. Be careful not to touch any of the components, contacts or connections.
12. All cautions and warnings on the board should be noted.
13. Use the correct mounting screws and do not over tighten the screws.
14. Keep the original packaging and the anti-static bag; in case the board has to be returned for repair or replacement.

Technical Support and Assistance

1. For the most updated information of NexCOBOT products, visit NexCOBOT's website at www.nexcobot.com.
2. For technical issues that require contacting our technical support team or sales representative, please have the following information ready before calling:
 - Product name and serial number
 - Detailed information of the peripheral devices
 - Detailed information of the installed software (operating system, version, application software, etc.)
 - A complete description of the problem
 - The exact wordings of the error messages

Warning!

1. Handling the unit: carry the unit with both hands and handle it with care.
2. Maintenance: to keep the unit clean, use only approved cleaning products or clean with a dry cloth.

Conventions Used in this Manual



Warning:

Information about certain situations, which if not observed, can cause personal injury. This will prevent injury to yourself when performing a task.



Caution:

Information to avoid damaging components or losing data.



Note:

Provides additional information to complete a task easily.

Global Service Contact Information

Headquarters

NEXCOM International Co., Ltd.

9F, No. 920, Zhongzheng Rd.,
Zhonghe District, New Taipei City, 23586,
Taiwan, R.O.C.
Tel: +886-2-8226-7786
Fax: +886-2-8226-7782
www.nexcom.com

Asia

Taiwan

NexAIoT Headquarters

Industry 4.0 and Cloud Services

12F, No.922, Zhongzheng Rd.,
Zhonghe District, New Taipei City,
23586, Taiwan, R.O.C.
Tel: +886-2-8226-7796
Fax: +886-2-8226-7926
Email: jacobhuang@nexaiot.com
www.nexaiot.com

NexAIoT Co., Ltd.

Taichung Office

16F, No.250, Sec.2, Chongde Rd.,
Beitun District,
Taichung City, 406, Taiwan, R.O.C.
Tel: +886-4-2249-1179
Fax: +886-4-2249-1172
Email: jacobhuang@nexaiot.com
www.nexaiot.com

NexCOBOT Taiwan Co., Ltd.

13F, No.916, Zhongzheng Rd.,
Zhonghe District,
New Taipei City, 23586, Taiwan, R.O.C.
Tel: +886-2-8226-7786
Fax: +886-2-8226-7926
Email: jennyshern@nexcobot.com
www.nexcobot.com

GreenBase Technology Corp.

13F, No.922, Zhongzheng Rd.,
Zhonghe District,
New Taipei City, 23586, Taiwan, R.O.C.
Tel: +886-2-8226-7786
Fax: +886-2-8226-7900
Email: vivianlin@nexcom.com.tw
www.nexcom.com.tw

DivioTec Inc.

19F-1A, No.97, Sec.4, ChongXin Rd.,
Sanhong District,
New Taipei City, 24161, Taiwan, R.O.C.
Tel: +886-2-8976-3077
Email: sales@diviotec.com
www.diviotec.com

AIoT Cloud Corp.

13F, No.922, Zhongzheng Rd.,
Zhonghe District,
New Taipei City, 23586, Taiwan, R.O.C.
Tel: +886-2-8226-7786
Fax: +886-2-8226-7782
Email: alantsai@aiotcloud.net
www.aiotcloud.dev

EMBUX TECHNOLOGY CO., LTD.

13F, No.916, Zhongzheng Rd.,
Zhonghe District,
New Taipei City, 23586, Taiwan, R.O.C.
Tel: +886-2-8226-7786
Fax: +886-2-8226-7782
Email: info@embux.com
www.embux.com

TMR TECHNOLOGIES CO., LTD.

13F, No.916, Zhongzheng Rd.,
Zhonghe District,
New Taipei City, 23586, Taiwan, R.O.C.
Tel: +886-2-8226-7786
Fax: +886-2-8226-7782
Email: services@tmrtek.com
www.tmrtek.com

China NEXSEC Incorporated

201, Floor 2, Unit 2, Building 15, Yard 3,
Gaolizhang Road, Haidian District,
Beijing, 100094, China
Tel: +86-10-5704-2680
Fax: +86-10-5704-2681
Email: marketing@nexsec.cn
www.nexsec.cn

NEXCOM Shanghai

Room 406-407, Building C, No 154, Lane 953,
Jianchuan Road, Minhang District,
Shanghai, 201108, China
Tel: +86-21-5278-5868
Fax: +86-21-3251-6358
Email: sales@nexcom.cn
www.nexcom.cn

NEXCOM Surveillance Technology Corp.

Floor 8, Building B3, Xiufeng Industrial Zone,
GanKeng Community, Buji Street,
LongGang District,
ShenZhen, 518112, China
Tel: +86-755-8364-7768
Fax: +86-755-8364-7738
Email: steveyang@nexcom.com.tw
www.nexcom.cn

NEXGOL Chongqing

1st Building No.999,
Star Boulevard, Yongchuan Dist,
Chongqing City, 402160, China
Tel: +86-23-4960-9080
Fax: +86-23-4966-5855
Email: sales@nexgol.com.cn
www.nexcom.cn

Beijing NexGemo Technology Co.,Ltd.

Room 205, No.1, Fazhan Rd.,
Beijing International Information Industry Base,
Changping District,
Beijing, 102206, China
Tel: +86-10-8072-2025
Fax: +86-10-8072-2022
Email: sales@nexgemo.cn
www.nexgemo.com

Japan

NEXCOM Japan

9F, Tamachi Hara Bldg.,
4-11-5, Shiba Minato-ku,
Tokyo, 108-0014, Japan
Tel: +81-3-5419-7830
Fax: +81-3-5419-7832
Email: sales@nexcom-jp.com
www.nexcom-jp.com

America

USA NEXCOM USA

46665 Fremont Blvd.,
Fremont CA 94538, USA
Tel: +1-510-656-2248
Fax: +1-510-656-2158
Email: sales@nexcom.com
www.nexcomusa.com

Package Contents

Before continuing, verify that the NEX 818 package that you received is complete. Your package should have all the items listed in the following table.

Item	Name	Qty
1	NEX818 Motherboard	1
2	SATA Cable	2
3	COM Port Cable	1
4	I/O Shield	1



Heat Spreader:

The heatspreader acts as a thermal coupling device to the module and is thermally coupled to the CPU via a thermal gap filler. On some modules, it may also be thermally coupled to other heat generating components with the use of additional thermal gap fillers. Although the heatspreader is the thermal interface where most of the heat generated by the module is dissipated, it is not to be considered as a heatsink. It has been designed as a thermal interface between the module and the application specific thermal solution.

Ordering Information

The following information below provides ordering information for NEX 818.

NEX 818 (P/N: 6879G0008180F)

Micro-ATX, 14th/13th/12th Gen Intel® Core™, LGA 1700 socket, processor max 125W TDPs, PCH Q670E, 4 x DDR5 U-DIMM, 1 x VGA, 1 x HDMI®, 1 x DP , 4 x USB 3.2 (Gen2), 3 x USB 3.2 (Gen1), 2 x USB 2.0, 2 x GbE LAN, 8 x SATA 3.0, 5 x RS232, 1 x RS-232/422/485, 2 x PCIe x16, 2 x PCIe x4, 4 x M.2, onboard TPM 2.0

Optional Accessories

- CPU Cooler (P/N: 685050200001F)
- CPU Cooler (P/N: 685050200002F)

CHAPTER 1: PRODUCT INTRODUCTION

Overview

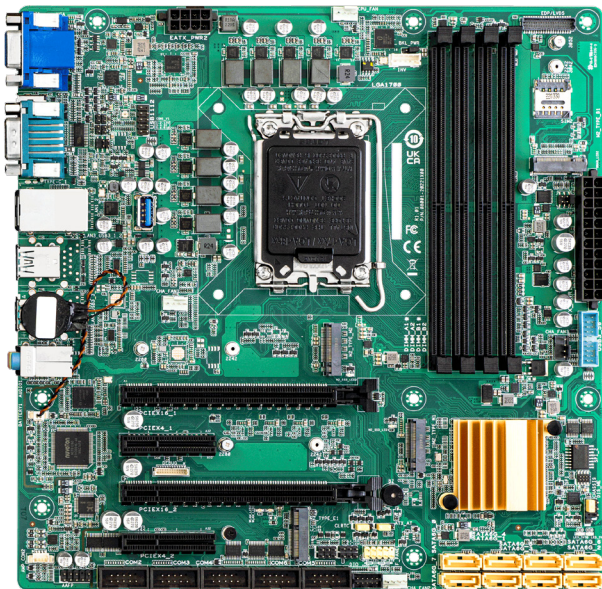

Key Features

- Intel® LGA1700 socket supports 14th/13th/12th Gen Intel® Core™ processor (max 125W)
- Intel® Q670E Express chipset
- 4 x DDR5 4000MHz up to 128GB
- 1 x Intel® i210-AT GbE, 1 x Intel® i219-LM GbE
- 2 x M.2 Key M slot, 1 x M.2 Key B slot + 1 x Micro SIM slot, 1 x M.2 Key E slot
- 8 x SATA 3.0 (6Gb/s), support Raid 0/1/5/10
- 1 x VGA, 1 x HDMI®, 1 x DP, 1 x LVDS/eDP
- 1 x RS-232/422/485, 5 x RS-232, 4 x USB 3.2 (Gen.2), 3 x USB 3.2 (Gen 1), 2 x USB 2.0
- 2 x PCIe x16, 2 x PCIe x4 slot
- 1 x CPU FAN, 3 x system FAN
- 24 + 8-pin ATX power input
- Micro ATX form factor (244mm x 244mm)

Hardware Specifications

CPU / Chipset

- 14th/13th/12th Gen Intel® Core™, LGA 1700 socket, processor max. 125W TDPs, Intel® Q670E PCH

Main Memory

- DIMM x 4, DDR5 (4000MHz x 4, up to 128GB)
- Non-ECC, un-buffered memory
- Dual-channel memory architecture

BIOS

- 256mb flash ROM, AMI BIOS

Display

- 1 x VGA connector (resolution up to 1920 x 1200 @60Hz)
- 1 x HDMI® 2.0 connector (resolution up to 4096 x 2160 @60Hz/30Hz, with digital audio)
- 1 x DP 1.4 connector (resolution up to 4096 x 2160 @24Hz, 3840 x 2160 @60 Hz, with digital audio)
- 1 x LVDS up to 1920 x 1080 @60Hz, dual channel 18/24 bit via pin header
- 1 x eDP up to 3840 x 2160 @30Hz via pin header
- Four independent display: HDMI® 2.0 x 1, DP x 1, VGA x 1, LVDS/eDP x 1

Storage

- 8 x SATA 3.0 port, supports RAID 0/1/5/10
- 2 x M.2 2242/80 Key M (PCIe 4 lanes Gen4.0, supports RAID 0/1/5/10)

Expansion Slots

- 1 x PCIe x16 slot (16 lanes, Gen5), (8 lanes when dual use PCIe x16 slots)
- 1 x PCIe x4 slot (open slot) (2 lanes, Gen3)
- 1 x PCIe x16 slot (8 lane, Gen5)
- 1 x PCIe x4 slot (4 lanes, Gen4)
- 1 x M.2 3042/3052 Key B (PCIe 3.0 x1/USB 3.2 Gen1) + 1 x Micro SIM slot
- 1 x M.2 2230 Key E (PCIe 3.0 x1/USB 2.0)

Audio

- Realtek ALC897 6-channel high definition audio codec

Watch Dog

- 1~255 step by software program

DIO

- 1 x 8-bit digital I/O interface

TPM

- TPM 2.0 on board

Rear I/O

- 1 x VGA, 1 x HDMI® 2.0, 1 x DP1.4
- 2 x RJ45 (1 x Intel® i210-AT GbE, 1 x Intel® i219-LM GbE)
- 4 x USB 3.2 Gen2
- 1 x COM DB-9 COM, supports RS-232/422/485, 5V/12V/RI)
- Audio Jack x 3: Line in, Mic in, Line out

Dimensions

- Micro-ATX form factor, 9.6"x9.6" (244mm x 244mm)

Power Requirement

- 1 x 24-pin ATX connector x 1, 8-pin ATX 12V power connector
- Support both AT and ATX power supply mode

Environment

- Board level operation temperature : 0°C to 60°C
- Storage temperature : -40°C to 85°C
- Relative humidity: 0% to 90% (operating, non-condensing)

Certifications

- Meet CE / FCC Class A

OS Support

- Windows® 10 64-bit, Windows® 11 64-bit

Knowing Your NEX 818

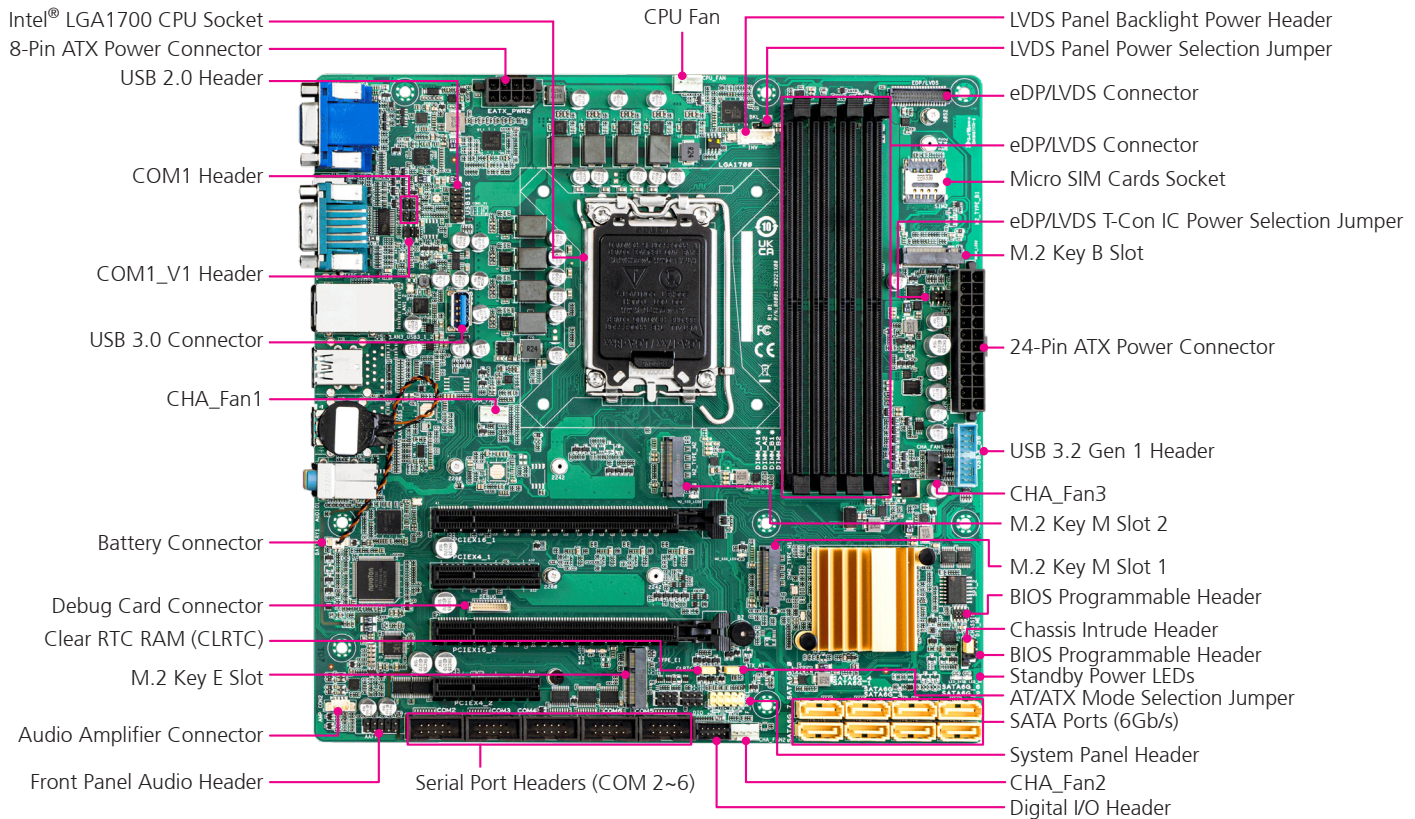

Edge I/O View

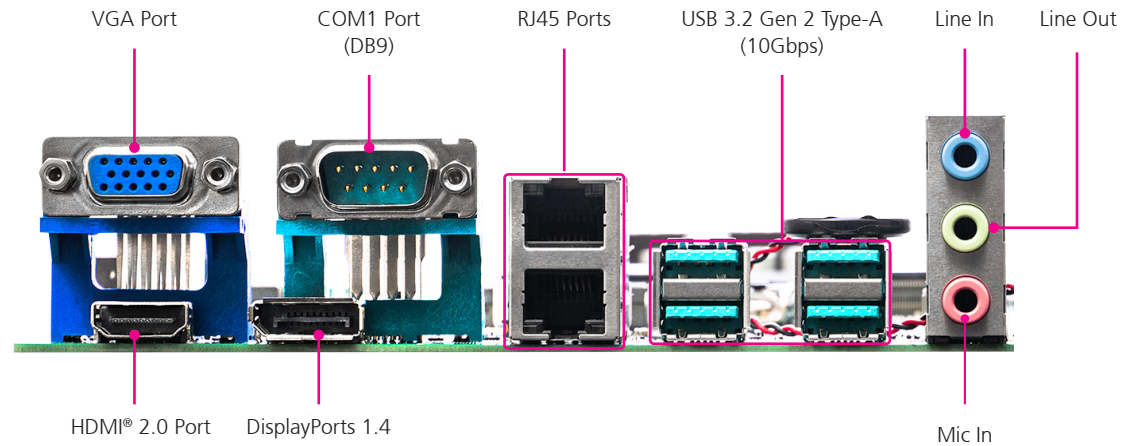

CHAPTER 2: JUMPERS AND CONNECTORS

This chapter describes how to set the jumpers and connectors on the NEX 818 motherboard.

Before You Begin

- Ensure you have a stable, clean working environment. Dust and dirt can get into components and cause a malfunction. Use containers to keep small components separated.
- Adequate lighting and proper tools can prevent you from accidentally damaging the internal components. Most of the procedures that follow require only a few simple tools, including the following:
 - A Philips screwdriver
 - A flat-tipped screwdriver
 - A set of jewelers screwdrivers
 - A grounding strap
 - An anti-static pad
- Using your fingers can disconnect most of the connections. It is recommended that you do not use needle-nosed pliers to disconnect connections as these can damage the soft metal or plastic parts of the connectors.
- Before working on internal components, make sure that the power is off. Ground yourself before touching any internal components, by touching a metal object. Static electricity can damage many of the electronic components. Humid environments tend to have less static electricity than

dry environments. A grounding strap is warranted whenever danger of static electricity exists.

Precautions

Computer components and electronic circuit boards can be damaged by discharges of static electricity. Working on computers that are still connected to a power supply can be extremely dangerous.

Follow the guidelines below to avoid damage to your computer or yourself:

- Always disconnect the unit from the power outlet whenever you are working inside the case.
- If possible, wear a grounded wrist strap when you are working inside the computer case. Alternatively, discharge any static electricity by touching the bare metal chassis of the unit case, or the bare metal body of any other grounded appliance.
- Hold electronic circuit boards by the edges only. Do not touch the components on the board unless it is necessary to do so. Don't flex or stress the circuit board.
- Leave all components inside the static-proof packaging that they shipped with until they are ready for installation.
- Use correct screws and do not over tighten screws.

Jumper Settings

A jumper is the simplest kind of electric switch. It consists of two metal pins and a cap. When setting the jumpers, ensure that the jumper caps are placed on the correct pins. When the jumper cap is placed on both pins, the jumper is short. If you remove the jumper cap, or place the jumper cap on just one pin, the jumper is open.

Refer to the illustrations below for examples of what the 2-pin and 3-pin jumpers look like when they are short (on) and open (off).

Two-Pin Jumpers: Open (Left) and Short (Right)

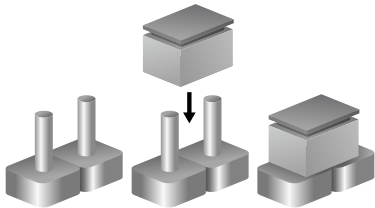

Three-Pin Jumpers: Pins 1 and 2 are Short

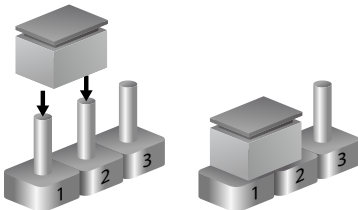

Locations of the Jumpers and Connectors

The figure below shows the location of the jumpers and connectors. Refer to this chapter for detailed pin settings and definitions of the connectors marked in pink on this figure.

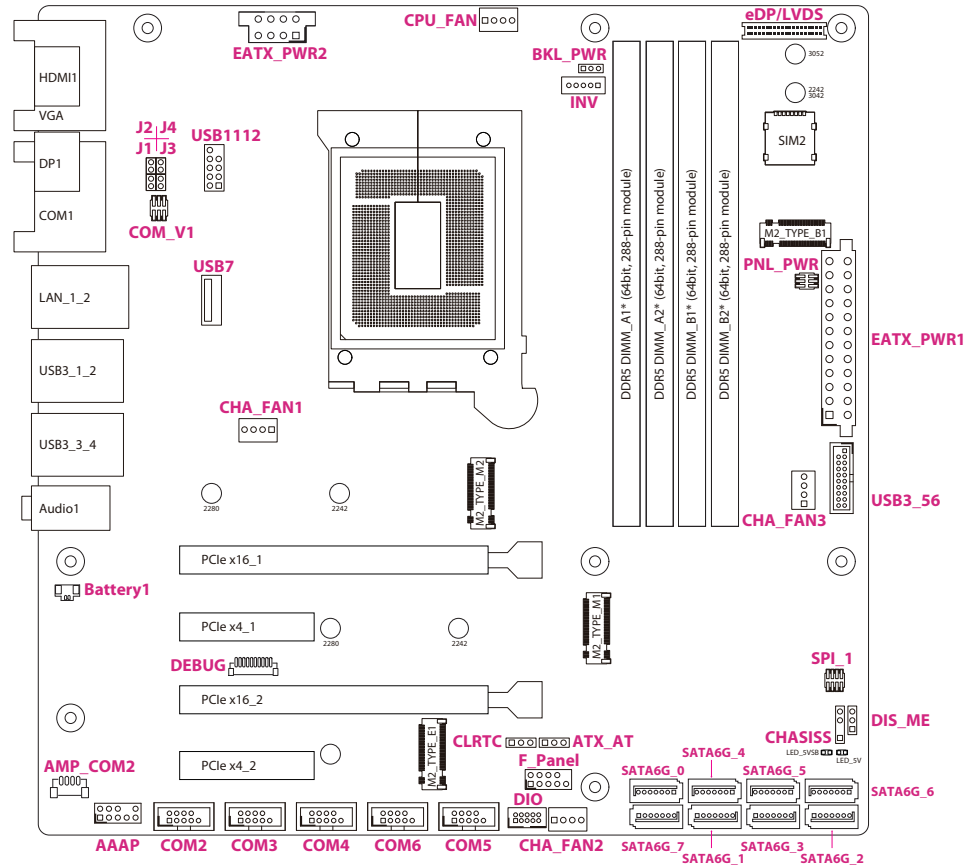

Jumpers

AT/ATX Mode Selection

Connector type: 3-pin header

Connector location: ATX_AT



1

Pin	Settings
1-2 On	ATX mode (default)
2-3 On	AT mode

LVDS Panel Power Selection

Connector type: 3-pin header

Connector location: BKL_PWR



1

Pin	Settings
1-2 On	+12V
2-3 On	+5V (default)



Note:

Switching between [AT](#) and [ATX modes](#) should be consistent with the settings in BIOS.

Chassis Intrusion

Connector type: 3-pin header

Connector location: CHASSIS



1

Pin	Settings
1-2 On	Enable
3-4 On	Disable (default)

RTC RAM Clear

Connector type: 3-pin header

Connector location: CLRTC



1

Pin	Settings
1-2 On	Normal (default)
2-3 On	Clear RTC

Erase the RTC RAM

1. Unplug the power cord when the computer is switched off.
2. Move the jumper cap from pins 1-2 (default) to pins 2-3 and stay for 5–10 seconds, then move the cap back to pins 1-2.
3. Power on the computer and enable the BIOS for configuration.



CAUTION:

DO NOT remove the cap from the default position of the CLRTC jumper, except when cleaning the RTC RAM. The system boot may fail if doing so. Moreover, if you fail to clean the CMOS data by removing the jumper cap, please remove the onboard battery first and then remove the jumper again to clean the CMOS data. Reinstall the battery when the cleaning process is done.

COM1 Ring/+5V/+12V Selection

Connector type: 6-pin header

Connector location: COM1_V1



Pin	Settings
1-2 On	+12V
3-4 On	+5V
5-6 On	Ring (default)

Intel® ME (Management Engine) Selection

Connector type: 3-pin header

Connector location: DIS_ME



Pin	Settings
1-2 On	Enabled ME flash security
2-3 On	Disabled ME flash security

COM1 RS-422/485 Terminator Selection

Connector location: J1, J2, J3, and J4

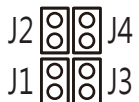

Pin	Settings
J1, J2, J3, J4 All Off	RS232
J1, J2, J3, J4 All On	RS485/RS422 with terminator (default)



Note:

Typically, you can configure the COM port in the [SIO Configuration](#) section of the BIOS. The jumpers shown here are reserved for specific status usage.

eDP/LVDS T-con IC Power Selection

Connector type: 6-pin header

Connector location: PNL_PWR



Pin	Settings
1-2 On	+3V
3-4 On	+12V
5-6 On	+5V (default)

Internal Connector Pin Definitions

Front Panel Audio Header

Connector type: 9-pin header

Connector location: AAFP

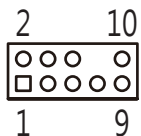

Pin	Definition	Pin	Definition
1	A_MIC2_L	2	A_GND
3	A_MIC2_R	4	(NC)
5	A_LINE2_R	6	A_JD_MIC2
7	A_JD_FRONT		
9	A_LINE2_L	10	A_JD_LINE2



Note:

Use this header to connect a high-definition front panel audio module.

Audio Amplifier Header

Connector type: 4-pin header

Connector location: AMP_CON2

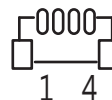

Pin	Definition
1	ROUTP
2	ROUTN
3	LOUTN
4	LOUTP

Battery Connector

Connector type: 2-pin header
Connector location: Battery1



Pin	Definition
1	GND
2	+BAT

CPU Fan and Chassis Fan Headers

Connector type: 4-pin header
Connector location: CPU_FAN, CHA_FAN 1~3

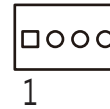

Pin	Definition
1	GND
2	SENSE
3	VCC
4	+5V



CAUTION:

DO NOT forget to connect the fan cables to the fan headers. Insufficient air flow inside the system may damage the motherboard components. These are not jumpers! **DO NOT** place jumper caps on the fan connectors!

Serial Port

Connector type: DB-9

Connector location: COM1

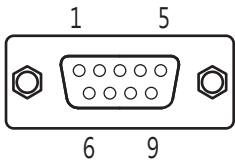

Pin	Definition	Pin	Definition
1	DCD# (422TXD- / 485TXD-)	2	RXD (422TXD+ / 485DATA+)
3	TXD (422RXD+)	4	DTR# (422RXD-)
5	GND	6	DSR#
7	RTS#	8	CTS#
9	RI / +5V / +12V	10	N.C.

Serial Port Headers

Connector type: 9-pin header

Connector location: COM2

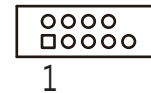

Pin	Definition	Pin	Definition
1	DDCD2#	2	RRXD2
3	TTXD2	4	DDTR2#
5	GND	6	DDSR2#
7	RRTS2#	8	CCCTS2#
9	RR12#		



Note:

COM1 can be used as an RS-232, RS-422 or RS-485 serial port. You can set up these serial ports using a compatible COM cable and configure them in the [SIO Configuration section](#) of the BIOS.

Connector type: 9-pin header
 Connector location: COM3

Connector type: 9-pin header
 Connector location: COM4

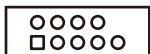

1



1

Pin	Definition	Pin	Definition
1	DCCD3	2	DRXD3
3	DTXD3	4	DDTR3
5	GND	6	DDSR3
7	DRTS3	8	DCTS3
9	DRI3		

Pin	Definition	Pin	Definition
1	DCCD4	2	DRXD4
3	DTXD4	4	DDTR4
5	GND	6	DDSR4
7	DRTS4	8	DCTS4
9	DRI4		

Connector type: 9-pin header
 Connector location: COM5

Connector type: 9-pin header
 Connector location: COM6

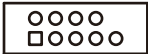

1



1

Pin	Definition	Pin	Definition
1	DCCD5	2	DRXD5
3	DTXD5	4	DDTR5
5	GND	6	DDSR5
7	DRTS5	8	DCTS5
9	DRI5		

Pin	Definition	Pin	Definition
1	DCCD6	2	DRXD6
3	DTXD6	4	DDTR6
5	GND	6	DDSR6
7	DRTS6	8	DCTS6
9	DRI6		

Debug Card Connector

Connector type: 12-pin header
Connector location: DEBUG

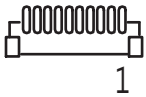

Pin	Definition
1	F_LAD0
2	F_LAD1
3	F_LAD2
4	F_LAD3
5	+3V
6	ESPI_CS0#
7	ESPI_RESET#
8	GND
9	ESPI_CLK
10	+3VSB_ATX
11	GND
12	(NC)

Digital I/O Header

Connector type: 10-pin header
Connector location: DIO1

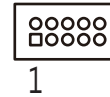

Pin	Definition	Pin	Definition
1	DIO_I#1	2	DIO_I#2
3	DIO_I#3	4	DIO_I#4
5	DIO_O#1	6	DIO_O#2
7	DIO_O#3	8	DIO_O#4
9	+5V_DIO	10	GND

24-pin ATX Power Connector

Connector type: 24-pin header
Connector location: EATX_PWR1

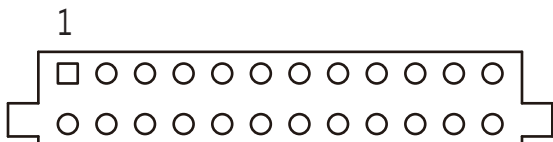

Pin	Definition	Pin	Definition
1	+3 Volts	2	+3 Volts
3	+3 Volts	4	-12 Volts
5	GND	6	GND
7	+5 Volts	8	PSON#
9	GND	10	GND
11	+5 Volts	12	GND
13	GND	14	GND
15	Power OK	16	floating
17	+5V Standby	18	+5 Volts
19	+12 Volts	20	+5 Volts
21	+12 Volts	22	+5 Volts
23	+3 Volts	24	GND

8-pin ATX Power Connector

Connector type: 8-pin header
Connector location: EATX_PWR2

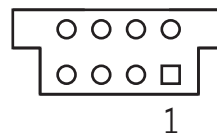

Pin	Definition	Pin	Definition
1	GND	2	+12V DC
3	GND	4	+12V DC
5	GND	6	+12V DC
7	GND	8	+12V DC



Note:

For a fully configured system, we recommend that you use a power supply unit (PSU) that complies with ATX 12V Specification 2.0 (or later) and provides a min. power of 330W.

We recommend that you use a PSU with higher power output when configuring a system with more power-consuming devices. The system may become unstable or may not boot up if the power is inadequate.

eDP/LVDS Connector

Connector type: 40-pin header

Connector location: eDP/LVDS

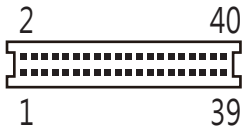

Pin	Definition	Pin	Definition
1	+V_PANEL	2	+V_Panel
3	ENABKL	4	PWM_OUT
5	+BLVCC	6	GND
7	+BLVCC	8	+BLVCC
9	GND	10	GND
11	LVDS0_D0-	12	LVDS1_D0-
13	LVDS0_D0+/eDP_HPDP	14	LVDS1_D0+
15	GND	16	GND
17	LVDS0_D1-/eDP_TX1N	18	LVDS1_D1-
19	LVDS0_D1+/eDP_TX1P	20	LVDS1_D1+

Pin	Definition	Pin	Definition
21	GND	22	GND
23	LVDS0_D2-/eDP_TX0N	24	LVDS1_D2-
25	LVDS0_D2+/eDP_TX0P	26	LVDS1_D2+
27	GND	28	GND
29	LVDS0_CLK-/eDP_AUXN	30	LVDS1_CLK-
31	LVDS0_CLK+/eDP_AUXP	32	LVDS1_CLK+
33	GND	34	GND
35	LVDS_D3-	36	LVDS1_D3-
37	LVDS_D3+	38	LVDS1_D3+
39	SPC1	40	SPD1

Front/System Panel Header

Connector type: 9-pin header

Connector location: F_PANEL

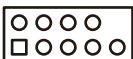

1

Pin	Definition	Pin	Definition
1	HDD_LED+	2	PLED+
3	HDD_LED-	4	PLED-
5	GND	6	F_PWRBTN#
7	RSTCON#_PANEL	8	GND
9	NC		

LVDS Panel Backlight Power Header

Connector type: 5-pin header

Connector location: INV

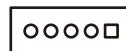

1

Pin	Definition
1	+BLVCC
2	VCON
3	GND
4	GND
5	INV_ENABKL

Serial ATA 6.0Gb/s Connectors

Connector type: Standard Serial ATA 7-pin

Connector location: SATA6G_0~7

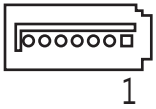

Pin	Definition
1	GND
2	RSATA_TXP
3	RSATA_TXN
4	GND
5	RSATA_RXN
6	RSATA_RXP
7	GND



Note:

When using hot-plug and NCQ, configure the [SATA Configuration](#) in BIOS to Disabled.

BIOS Programmable Header

Connector type: 8-pin

Connector location: SPI_1



Pin	Definition	Pin	Definition
1	+3V_SPI	2	GND
3	S_BIOS_CS0#_1Q	4	S_BIOS_CLK_1Q
5	S_BIOS_MISO_1Q	6	S_BIOS_MOSI_1Q
7	(NC)	8	(NC)

USB 2.0 Header

Connector type: 9-pin header
Connector location: USB1112

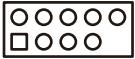

1

Pin	Definition	Pin	Definition
1	+5V_USB2_P1112	2	+5V_USB2_P1112
3	S_USB_PN11	4	S_USB_PN12
5	S_USB_PP11	6	S_USB_PP12
7	GND	8	GND
9		10	(NC)

USB 3.2 Gen 1 Header

Connector type: 19-pin header
Connector location: USB3_56

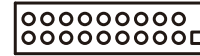

1

Pin	Definition	Pin	Definition
1	+5V_USB3_P56	11	S_USB_PP13
2	S_U3RXDN5	12	S_USB_PN13
3	S_U3RXDP5	13	GND
4	GND	14	S_U3TXDP6
5	S_U3TXDN5	15	S_U3TXDN6
6	S_U3TXDP5	16	GND
7	GND	17	S_U3RXDP6
8	S_USB_PN12	18	S_U3RXDN6
9	S_USB_PP12	19	+5V_USB3_P56
10	GND		



Note:

It is recommended to install the relevant driver to fully support USB 3.2 Gen 1 on Windows 10, as this header is based on xHCI. Connected USB 3.0 devices will operate in xHCI mode.

LED Indicators

LAN 1/2 Ports LEDs

ACT/LINK

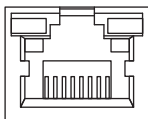

Activity/Link Status	Description
Off	No Link
Yellow	Linked
Blinking	Data Activity
Yellow (Blinking to steady)	Ready to wake up from S5 mode

Speed

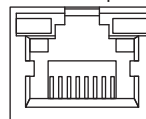

Speed Status	Description
Off	10Mbps Link
Orange	100Mbps Link
Green	1Gbps link

Standby Power LEDs

This motherboard has 2 standby power LEDs to indicate the status of the system in power-on, sleep or soft-off mode. It reminds the user to shut down and unplug the power cord before removing or unplugging any components from the motherboard. Refer to the illustration on the right hand side to see the location of the LEDs.

Connector location: LED_+5V and LED_+5VSB

LED_5V: Illuminates when the system is in standby mode.

LED_5VSB: Illuminates when the system main power is on.

System State	LED	Status
S0 State	LED_5V	On
	LED_5VSB	On
S5 State	LED_5VSB	On

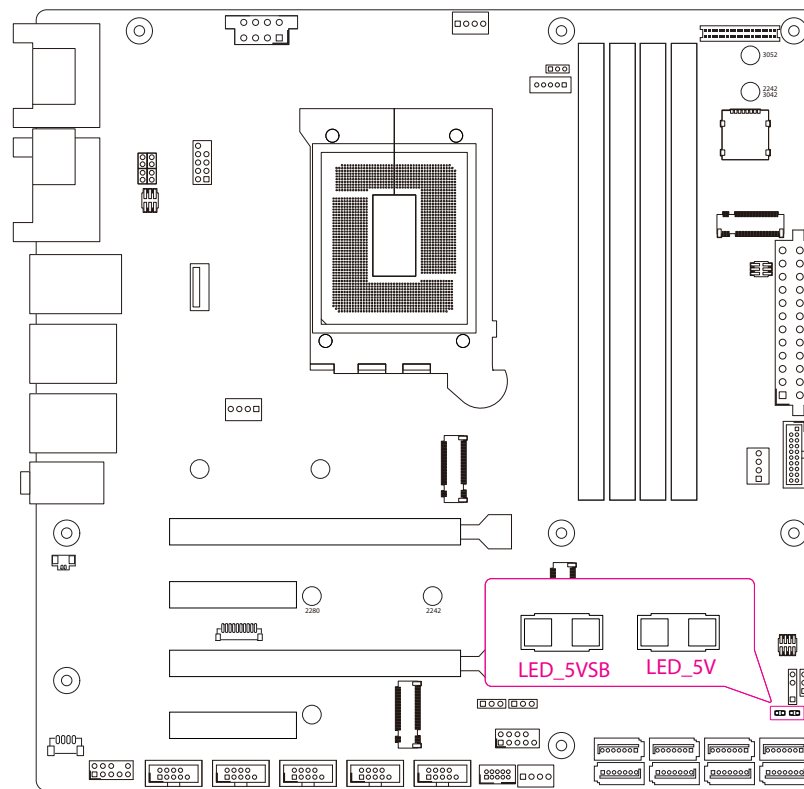

Block Diagram

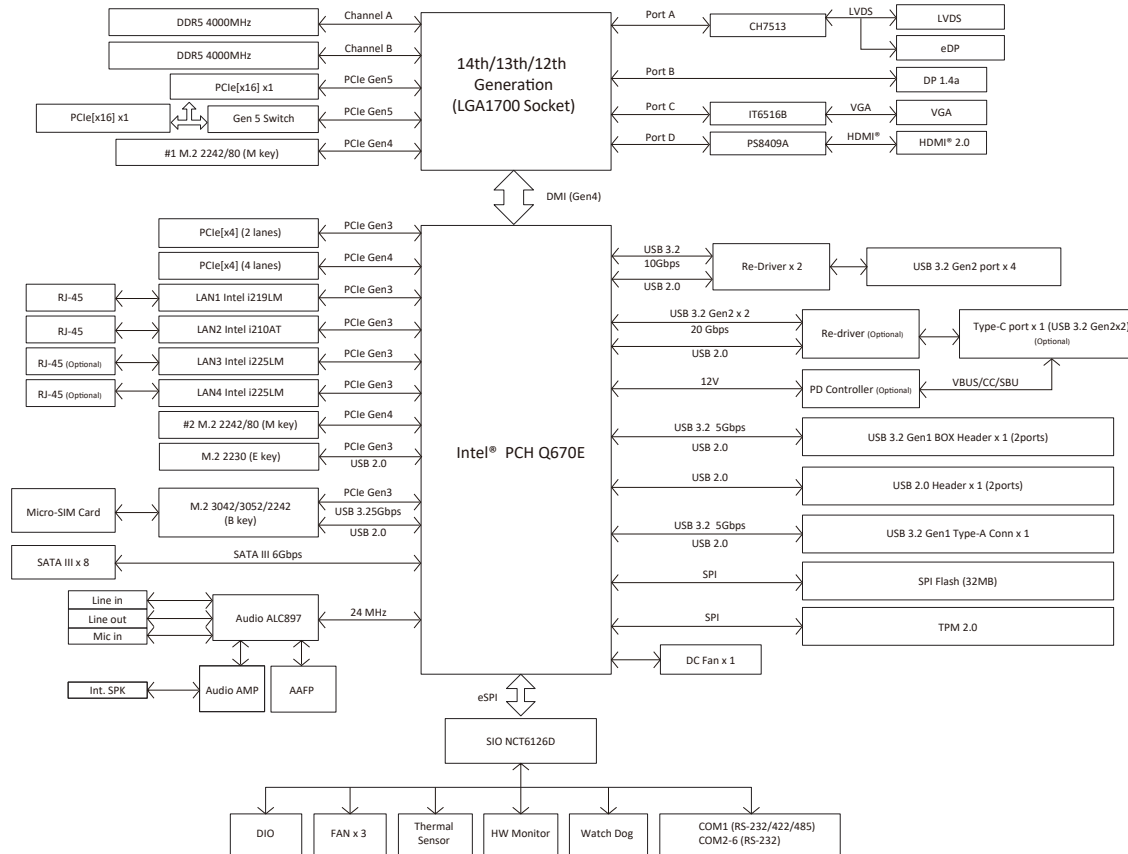

CHAPTER 3: BIOS SETUP

This chapter describes how to use the BIOS setup program for NEX 818. The BIOS screens provided in this chapter are for reference only and may change if the BIOS is updated in the future.

To check for the latest updates and revisions, visit the NexCOBOT website at www.nexcobot.com.

About BIOS Setup

The BIOS (Basic Input and Output System) Setup program is a menu driven utility that enables you to make changes to the system configuration and tailor your system to suit your individual work needs. It is a ROM-based configuration utility that displays the system's configuration status and provides you with a tool to set system parameters.

These parameters are stored in non-volatile battery-backed-up CMOS RAM that saves this information even when the power is turned off. When the system is turned back on, the system is configured with the values found in CMOS.

With easy-to-use pull down menus, you can configure such items as:

- Hard drives, diskette drives, and peripherals
- Video display type and display options
- Password protection from unauthorized use
- Power management features

The settings made in the setup program affect how the computer performs. It is important, therefore, first to try to understand all the setup options, and second, to make settings appropriate for the way you use the computer.

When to Configure the BIOS

This program should be executed under the following conditions:

- When changing the system configuration
- When a configuration error is detected by the system and you are prompted to make changes to the setup program
- When resetting the system clock
- When redefining the communication ports to prevent any conflicts
- When making changes to the Power Management configuration
- When changing the password or making other changes to the security setup

Normally, CMOS setup is needed when the system hardware is not consistent with the information contained in the CMOS RAM, whenever the CMOS RAM has lost power, or the system features need to be changed.

Default Configuration

Most of the configuration settings are either predefined according to the Load Optimal Defaults settings which are stored in the BIOS or are automatically detected and configured without requiring any actions. There are a few settings that you may need to change depending on your system configuration.

Entering Setup











When the system is powered on, the BIOS will enter the Power-On Self Test (POST) routines. These routines perform various diagnostic checks; if an error is encountered, the error will be reported in one of two different ways:

- If the error occurs before the display device is initialized, a series of beeps will be transmitted.
- If the error occurs after the display device is initialized, the screen will display the error message.

Powering on the computer and immediately pressing allows you to enter Setup.

Press the  key to enter Setup:

Legends

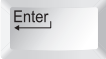
Key	Function
	Moves the highlight left or right to select a menu.
	Moves the highlight up or down between sub-menu or fields.
	Exits the BIOS Setup Utility.
	Scrolls forward through the values or options of the highlighted field.
	Scrolls backward through the values or options of the highlighted field.
	Selects a field.
	Displays General Help.
	Load previous values.
	Load optimized default values.
	Saves and exits the Setup program.
	Press <Enter> to enter the highlighted sub-menu

Scroll Bar

When a scroll bar appears to the right of the setup screen, it indicates that there are more available fields not shown on the screen. Use the up and down arrow keys to scroll through all the available fields.

Submenu

When “▶” appears on the left of a particular field, it indicates that a submenu which contains additional options are available for that field. To display the submenu, move the highlight to that field and press  .

BIOS Setup Utility

Once you enter the AMI BIOS Setup Utility, the Main Menu will appear on the screen. The main menu allows you to select from several setup functions and one exit. Use arrow keys to select among the items and press  to accept or enter the submenu.

Main

The Main menu is the first screen that you will see when you enter the BIOS Setup Utility.

System Date

The date format is <day>, <month>, <date>, <year>. Day displays a day, from Monday to Sunday. Month displays the month, from January to December. Date displays the date, from 1 to 31. Year displays the year, from 2005 to 2099.

System Time

The time format is <hour>, <minute>, <second>. The time is based on the 24-hour military-time clock. For example, 1 p.m. is 13:00:00. Hour displays hours from 00 to 23. Minute displays minutes from 00 to 59. Second displays seconds from 00 to 59.

Advanced

The Advanced menu allows you to configure your system for basic operation. Some entries are defaults required by the system board, while others, if enabled, will improve the performance of your system or let you set some features according to your preference.



Setting incorrect field values may cause the system to malfunction.

Case Open Warning

Enable or disable case open detection feature. The system will show the case open message during the computer POST (Power-On Self-Tests) if this feature is configured to Enabled. Refer to [Chassis Intrusion](#) to short the pins.

CPU Configuration

This section is used to display the current CPU information and configure the installed CPU. The submenu may vary depending on the installed CPU.

> Performance-core Information

Display the P-Core information.

> Hyper-threading

Enable or disable hyper-threading technology. The options may vary depending on the CPU installed

> Intel (VMX) Virtualization Technology

When set to Enabled, the VMM can use the additional hardware capabilities provided by Vanderpool Technology.

Trusted Computing

This section is used to configure the settings for the TPM (Trusted Platform Module).

> Security Device Support

Enable or disable BIOS support for security device. O.S will not show Security Device. TCG EFI protocol and INT1A interface will not be available.

> SHA256 PCR Bank

Enable or disable SHA256 PCR Bank.

> SHA384 PCR Bank

Enable or disable SHA384 PCR Bank.

> Pending operation

Schedule an operation for the security device. Reboots the computer to change the state of the Security Device.

> Platform Hierarchy

Enable or disable platform hierarchy.

> Storage Hierarchy

Enable or disable storage hierarchy.

> Endorsement Hierarchy

Enable or disable endorsement hierarchy.

> Physical Presence Spec Version

Configure the physical presence spec version.

> Device Select

Configure the TPM version. TPM 1.2 will restrict support to TPM 1.2 devices and TPM 2.0 will restrict support to TPM 2.0 devices. Auto will support both TPM 1.2 and 2.0 devices with the default set to TPM 2.0 devices if not found, and TPM 1.2 devices will be enumerated.

PTT Configuration

This section is used to configure the settings for the PTT.

> TPM Device Selection

Use to select a TPM device. The options are PTT and dTPM.

Warning! All data saved on it will be lost, when PTT is disabled.

SATA Configuration

This section is used to display and configure the SATA connection of the device.

> SATA Controller(s)

Enable or disable the SATA controller. The following options will appear when selecting Enabled.

> Enable VMD controller

Enable or disable the VMD controller. When enabled, the following submenus will be available.

> SATA6G_0/1/2/3/4/5/6/7

> Port 0/1/2/3/4/5/6/7

Enable or disable the SATA Port.

> Hot Plug

Enable or disable hot plugging feature on each SATA port.

USB Configuration

This section is used to configure the USB functionality and related settings. No information will appear if no USB device is plugged in.

> USB Mass Storage Driver Support

Enable or disable USB mass storage driver support.

Hardware Monitor

This section is used to monitor hardware status such as temperature, fan speed, and voltages.

> DC FAN Control

Enable or disable the DC FAN.

> System Smart Fan1/2 and CPU Smart Fan Setting

> System Smart Fan1/2 and CPU Smart Fan Setting > Fan Mode

Select a fan mode for each of the fans. The options are Manual Mode, Thermal Cruise, Smart Fan IV, and Speed Cruise.

The following options will appear when selecting [Manual Mode](#).

> System Smart Fan and CPU Smart Fan Setting > Fan Mode > Manual PWM

Configure fan speed manually.

The following options appear when set the fan mode to [Thermal Cruise](#).

> System Smart Fan and CPU Smart Fan Setting > Fan Mode > Critical Temperature

Configure a value between 0 and 255.

> System Smart Fan and CPU Smart Fan Setting > Fan Mode > Enable critical duty

Enable or disable the enable critical duty.

> System Smart Fan and CPU Smart Fan Setting > Fan Mode > Critical duty value

Configure a value between 0 and 127.

> System Smart Fan and CPU Smart Fan Setting > Fan Mode > Fan target temperature

Configure a value between 0 and 127.

> System Smart Fan and CPU Smart Fan Setting > Fan Mode > Tolerance value

Configure a value between 0 and 7.

> System Smart Fan and CPU Smart Fan Setting > Fan Mode > Stop duty

Enable or disable the stop duty.

> System Smart Fan and CPU Smart Fan Setting > Fan Mode > Stop value

Configure a value between 0 and 127.

> System Smart Fan and CPU Smart Fan Setting > Fan Mode > Startup value

Configure a value between 0 and 127.

> System Smart Fan and CPU Smart Fan Setting > Fan Mode > Stop time

Configure a value between 0 and 127.

The following options appear when set the fan mode to [Speed Cruise](#).

> System Smart Fan and CPU Smart Fan Setting > Fan Mode > Fan step up value

Configure a value between 0 and 15.

> System Smart Fan and CPU Smart Fan Setting > Fan Mode > Fan step down value

Configure a value between 0 and 15.

> System Smart Fan and CPU Smart Fan Setting > Fan Mode > Target speed count

Configure a value between 0 and 4095.

> System Smart Fan and CPU Smart Fan Setting > Fan Mode > Tolerance value

Configure a value between 0 and 63.

The following options appear when set the fan mode to [Smart Fan IV](#).

> **System Smart Fan and CPU Smart Fan Setting > Fan Mode > Temperature 1/2/3/4**

Configure the temperature for Smart Fan IV Mode. The value is between 0 and 255.

> **System Smart Fan and CPU Smart Fan Setting > Fan Mode > FD/RPM 1/2/3/4**

Configure a value for Fan Duty/RPM. The value is between 0 and 255.

> **System Smart Fan and CPU Smart Fan Setting > Fan Mode > Critical Temperature**

Configure a value between 0 and 255.

> **System Smart Fan and CPU Smart Fan Setting > Fan Mode > Critical Tolerance**

Configure a value between 0 and 7.

> **System Smart Fan and CPU Smart Fan Setting > Fan Mode > Enable critical duty**

Enable or disable the enable critical duty.

> **System Smart Fan and CPU Smart Fan Setting > Fan Mode > Tolerance value**

Configure a value between 0 and 7.

> **System Smart Fan and CPU Smart Fan Setting > Fan Mode > RPM Mode**

Enable or disable Smart Fan IV close loop fan control RPM Mode.

SIO Configuration

This section is used to configure the serial ports.

> **[*Active*] Serial Port 1/2/3/4/5/6**

Press Enter to configure each serial port in each of the following options.

> **[*Active*] Serial Port 1/2/3/4/5/6 > Use this device**

Enable or disable the serial port. When enabled, the following options will be available.

> **[*Active*] Serial Port 1/2/3/4/5/6 > Use this device > Possible**

Configures the base address for the serial port.

> **[*Active*] Serial Port 1 > Use this device > Mode**

Configures the serial port mode to RS232, RS422, or RS485.

AMT Configuration

This section is used to configure AMT settings.

> AMT BIOS Features

Enable or disable AMT BIOS features. When disabled, user will no longer be able to access [MEBx](#) setup.

PCH-FW Configuration

This section is used to display the firmware information and configure the firmware update.

> Firmware Update Configuration

Press Enter to configure the following submenu.

> Firmware Update Configuration > Me FW Image Re-Flash

Enable or disable ME FW Image Re-Flash.

> Firmware Update Configuration > FW Update

Enable or disable the firmware update function.

NVMe Configuration

This section is used to display the information and configure the NVMe devices that are installed on the system.

Power Management

This section is used to configure the power management features.

> Power Mode

Configure the power supply mode. The options are ATX Type and AT Type.

The following options appear when selecting ATX Type.

> Power Mode > Restore AC Power Loss

Select the AC power state when power is re-applied after a power failure.

Last State: The system maintains its state, whether it was in the off or on state.

Always On: The system will go into the On state after a loss of AC power.

Always Off: The system will go into the Off state after a loss of AC power.

> Power Mode > RI Wake Event

Enable or disable the system to wake up from RI.

> Power Mode > RTC Wake system from S5

Enable or disable the RTC wake up from S5.

Disabled: Disables the system wake up from S5 state.

Fixed Time: System will wake up on the hr::min::sec specified.

Dynamic Time: System will wake up on the current time + increase

minute(s).

Digital IO Port Configuration

This section is used to configure digital I/O port settings.

> DIO Port1 to DIO Port4

Configure DIO port1 to port4 as input or output.

The following options will appear when selecting Output.

> DIO Port1 to DIO Port4 > Output Level

Configure the output level as high or low.

> DIO Port5 to DIO Port8

Configure DIO port5 to port8 as input or output.

Chipset Menu

This section gives you functions to configure the system based on the specific features of the chipset. The chipset manages bus speeds and access to system memory resources.

System Agent (SA) Configuration

Press Enter to configure the following submenus.

> System Agent (SA) Configuration > Primary Display

Select which graphics controller should be the primary display. The options are Auto, IGFX, PEG Slot, and PCH PCI.

> System Agent (SA) Configuration > PCIEX16_1 Gen Speed

Select a PCI Express port speed. The options are Auto, Gen1, Gen2, Gen3, Gen4, and Gen5.

> System Agent (SA) Configuration > PCIEX16_2 Gen Speed

Select a PCI Express port speed. The options are Auto, Gen1, Gen2, Gen3, Gen4, and Gen5.

> System Agent (SA) Configuration > CH7513

Select a PCI Express port speed. The options are Auto, Gen1, Gen2, Gen3, Gen4, and Gen5. The options are Disabled, eDP mode, and LVDS.

The following option will appear when selecting [LVDS](#) mode.

> System Agent (SA) Configuration > CH7513 > LVDS Panel Type

Select an appropriate setting for LCD panel used by internal graphics device.

> System Agent (SA) Configuration > CH7513 > LVDS Backlight Invert

The options are Normal and Invert.

> System Agent (SA) Configuration > CH7513 > LVDS Backlight Output Level

Configure the LVDS backlight output level. The options are 10%, 20%, 30%, 40%, 50%, 60%, 70%, 80%, 90%, and 100%.

PCH-IO Configuration

Press Enter to configure the following submenus.

> PCH-IO Configuration > HD Audio

Control detection of the HD audio device.

Disabled: HD audio will be unconditionally disabled.

Enabled: HD audio will be unconditionally enabled.

Security

This section is used to configure the security related options for BIOS protection.

Administrator Password

Select this to configure the administrator's password.

User Password

Select this to configure the user's password.

Secure Boot

Press Enter to configure the following submenus.

> Secure Boot

Enable or disable the secure boot. The platform key (PK) enrolled and the system is in user mode when secure boot is enabled. A platform reset is required to change modes.

> Secure Boot Mode

Select a secure boot mode for the system. The options are standard and custom. When in custom mode, secure boot policy variables can be configured by a physically present user without full authentication. More options are available if the option is set to **Custom**.

Secure Boot > Restore Factory Keys

Allow you to install factory default secure boot key databases.

Secure Boot > Reset To Setup Mode

Delete all Secure Boot Key databases from NVRAM.

Secure Boot > Key Management

Enable experienced users to modify Secure Boot variables, which includes the following items.

Secure Boot > Key Management > Factory Key Provision

Install the factory default secure boot keys after the platform has been reset and while the system is in the setup mode.

Secure Boot > Key Management > Enroll Efi Image

Run the image in Secure Boot Mode.

Secure Boot > Key Management > Export Secure Boot Variables

Copy NVRAM content of Secure Boot variables to files in a root folder on a file system device.

Secure Boot > Key Management > Platform Key (PK)/Key Exchange Keys/Authorized Signatures/Forbidden Signatures/Authorized TimeStamps/OsRecovery Signatures

Enroll factory defaults or load the keys from a file.

Boot

This section is used to configure the boot features.

Boot Configuration

Boot Configuration > Quiet Boot

Enable or disable Quiet Boot option.

Enabled: Displays OEM logo instead of the POST messages.

Disabled: Displays normal POST messages.

Boot Configuration > Network Stack

Enable or disable UEFI network stack.

Fixed Boot Order Priorities

Fixed Boot Order Priorities > Boot Options 1-10

Adjust the boot sequence of the system. Boot Option #1 is the first boot device that the system will boot from, next will be Boot Option #2 and so forth.

Save & Exit

Save Changes and Reset

Press Enter to save the changes and reset. Confirm by selecting Yes when a dialogue box appears.

Discard Changes and Exit

Press Enter to exit the BIOS without saving the changes. You may be prompted to confirm again before exiting.

Restore Defaults

Press Enter to restore the BIOS to the default settings. Confirm by selecting Yes when a dialogue box appears.

MEBx

This section is used to display and configure the MEBx features.

Intel® ME Password

By default, the password is admin. The default password must be changed when accessing the Intel MEBx configuration menu for the first time.