



NEXCOM International Co., Ltd.

Intelligent Platform & Services Business Unit
Embedded Computing (Industrial Motherboard)

NEX 812

User Manual

CONTENTS

Preface

Copyright	iv
Disclaimer	iv
Acknowledgements	iv
Regulatory Compliance Statements	iv
Declaration of Conformity	iv
RoHS Compliance	v
Warranty and RMA	vi
Safety Information	viii
Installation Recommendations	viii
Safety Precautions	ix
Technical Support and Assistance	x
Conventions Used in this Manual	x
Global Service Contact Information	xi
Package Contents	xiii
Ordering Information	xiv

Chapter 1: Product Introduction

Overview	1
Key Features	1
Hardware Specifications	2
Knowing Your NEX 812	4
Edge I/O View	5

Chapter 2: Jumpers and Connectors

Before You Begin	6
Precautions	6
Jumper Settings	7
Locations of the Jumpers and Connectors	8
Jumpers	9
CMOS Clear Selection	9
Chassis Intrusion	9
Connector Pin Definitions	10
24-pin ATX Power Connector	10
8-pin ATX Power Connector	10
TPM Header	11
CPU Fan Connector	11
Chassis Fan Connectors	12
BIOS Programmable Connector	12
System Panel Connector	13
Digital I/O Connector	13
COM2 to COM6 Internal Serial Port Connectors	14
Serial ATA 6.0Gb/s Connector 1	14
Serial ATA 6.0Gb/s Connector 2	15
Serial ATA 6.0Gb/s Connector 3	15
Serial ATA 6.0Gb/s Connector 4	16
Serial ATA 6.0Gb/s Connector 5	16
Serial ATA 6.0Gb/s Connector 6	17
USB 2.0 Connector	17



USB 2.0 Connector.....	18
Speaker-out Connector.....	18
Block Diagram	19

Chapter 3: BIOS Setup

About BIOS Setup.....	20
When to Configure the BIOS.....	20
Default Configuration	21
Entering Setup.....	21
Legends.....	21
BIOS Setup Utility.....	23
Main	23
Advanced.....	24
Chipset.....	35
Security	37
Boot.....	38
Save & Exit	38



PREFACE

Copyright

This publication, including all photographs, illustrations and software, is protected under international copyright laws, with all rights reserved. No part of this manual may be reproduced, copied, translated or transmitted in any form or by any means without the prior written consent from NEXCOM International Co., Ltd.

Disclaimer

The information in this document is subject to change without prior notice and does not represent commitment from NEXCOM International Co., Ltd. However, users may update their knowledge of any product in use by constantly checking its manual posted on our website: <http://www.nexcom.com>. NEXCOM shall not be liable for direct, indirect, special, incidental, or consequential damages arising out of the use of any product, nor for any infringements upon the rights of third parties, which may result from such use. Any implied warranties of merchantability or fitness for any particular purpose is also disclaimed.

Acknowledgements

NEX 812 is a trademark of NEXCOM International Co., Ltd. All other product names mentioned herein are registered trademarks of their respective owners.

Regulatory Compliance Statements

This section provides the FCC compliance statement for Class A devices and describes how to keep the system CE compliant.

Declaration of Conformity

FCC

This equipment has been tested and verified to comply with the limits for a Class A digital device, pursuant to Part 15 of FCC Rules. These limits are designed to provide reasonable protection against harmful interference when the equipment is operated in a commercial environment. This equipment generates, uses, and can radiate radio frequency energy and, if not installed and used in accordance with the instructions, may cause harmful interference to radio communications. Operation of this equipment in a residential area (domestic environment) is likely to cause harmful interference, in which case the user will be required to correct the interference (take adequate measures) at their own expense.

CE

The product(s) described in this manual complies with all applicable European Union (CE) directives if it has a CE marking. For computer systems to remain CE compliant, only CE-compliant parts may be used. Maintaining CE compliance also requires proper cable and cabling techniques.

RoHS Compliance



NEXCOM RoHS Environmental Policy and Status Update

NEXCOM is a global citizen for building the digital infrastructure. We are committed to providing green products and services, which are compliant with European Union RoHS (Restriction on Use of Hazardous Substance in Electronic Equipment) directive 2011/65/EU, to be your trusted green partner and to protect our environment.

RoHS restricts the use of Lead (Pb) < 0.1% or 1,000ppm, Mercury (Hg) < 0.1% or 1,000ppm, Cadmium (Cd) < 0.01% or 100ppm, Hexavalent Chromium (Cr6+) < 0.1% or 1,000ppm, Polybrominated biphenyls (PBB) < 0.1% or 1,000ppm, and Polybrominated diphenyl Ethers (PBDE) < 0.1% or 1,000ppm.

In order to meet the RoHS compliant directives, NEXCOM has established an engineering and manufacturing task force in to implement the introduction of green products. The task force will ensure that we follow the standard NEXCOM development procedure and that all the new RoHS components and new manufacturing processes maintain the highest industry quality levels for which NEXCOM are renowned.

The model selection criteria will be based on market demand. Vendors and suppliers will ensure that all designed components will be RoHS compliant.

How to recognize NEXCOM RoHS Products?

For existing products where there are non-RoHS and RoHS versions, the suffix "(LF)" will be added to the compliant product name.

All new product models launched after January 2013 will be RoHS compliant. They will use the usual NEXCOM naming convention.

Warranty and RMA

NEXCOM Warranty Period

NEXCOM manufactures products that are new or equivalent to new in accordance with industry standard. NEXCOM warrants that products will be free from defect in material and workmanship for 2 years, beginning on the date of invoice by NEXCOM.

NEXCOM Return Merchandise Authorization (RMA)

- Customers shall enclose the “NEXCOM RMA Service Form” with the returned packages.
- Customers must collect all the information about the problems encountered and note anything abnormal or, print out any on-screen messages, and describe the problems on the “NEXCOM RMA Service Form” for the RMA number apply process.
- Customers can send back the faulty products with or without accessories (manuals, cable, etc.) and any components from the card, such as CPU and RAM. If the components were suspected as part of the problems, please note clearly which components are included. Otherwise, NEXCOM is not responsible for the devices/parts.
- Customers are responsible for the safe packaging of defective products, making sure it is durable enough to be resistant against further damage and deterioration during transportation. In case of damages occurred during transportation, the repair is treated as “Out of Warranty.”
- Any products returned by NEXCOM to other locations besides the customers’ site will bear an extra charge and will be billed to the customer.

Repair Service Charges for Out-of-Warranty Products

NEXCOM will charge for out-of-warranty products in two categories, one is basic diagnostic fee and another is component (product) fee.

System Level

- Component fee: NEXCOM will only charge for main components such as SMD chip, BGA chip, etc. Passive components will be repaired for free, ex: resistor, capacitor.
- Items will be replaced with NEXCOM products if the original one cannot be repaired. Ex: motherboard, power supply, etc.
- Replace with 3rd party products if needed.
- If RMA goods can not be repaired, NEXCOM will return it to the customer without any charge.

Board Level

- Component fee: NEXCOM will only charge for main components, such as SMD chip, BGA chip, etc. Passive components will be repaired for free, ex: resistors, capacitors.
- If RMA goods can not be repaired, NEXCOM will return it to the customer without any charge.

Warnings

Read and adhere to all warnings, cautions, and notices in this guide and the documentation supplied with the chassis, power supply, and accessory modules. If the instructions for the chassis and power supply are inconsistent with these instructions or the instructions for accessory modules, contact the supplier to find out how you can ensure that your computer meets safety and regulatory requirements.

Cautions

Electrostatic discharge (ESD) can damage system components. Do the described procedures only at an ESD workstation. If no such station is available, you can provide some ESD protection by wearing an antistatic wrist strap and attaching it to a metal part of the computer chassis.

Safety Information

Before installing and using the device, note the following precautions:

- Read all instructions carefully.
- Do not place the unit on an unstable surface, cart, or stand.
- Follow all warnings and cautions in this manual.
- When replacing parts, ensure that your service technician uses parts specified by the manufacturer.
- Avoid using the system near water, in direct sunlight, or near a heating device.
- The load of the system unit does not solely rely for support from the rackmounts located on the sides. Firm support from the bottom is highly necessary in order to provide balance stability.
- The computer is provided with a battery-powered real-time clock circuit. There is a danger of explosion if battery is incorrectly replaced. Replace only with the same or equivalent type recommended by the manufacturer. Discard used batteries according to the manufacturer's instructions.

Installation Recommendations

Ensure you have a stable, clean working environment. Dust and dirt can get into components and cause a malfunction. Use containers to keep small components separated.

Adequate lighting and proper tools can prevent you from accidentally damaging the internal components. Most of the procedures that follow require only a few simple tools, including the following:

- A Philips screwdriver
- A flat-tipped screwdriver
- A grounding strap
- An anti-static pad

Using your fingers can disconnect most of the connections. It is recommended that you do not use needle-nose pliers to disconnect connections as these can damage the soft metal or plastic parts of the connectors.

Safety Precautions

1. Read these safety instructions carefully.
2. Keep this User Manual for later reference.
3. Disconnect the equipment from any AC outlet before cleaning or installing a component inside the chassis. Use a damp cloth. Do not use liquid or spray detergents for cleaning.
4. To prevent electrostatic build-up, leave the board in its anti-static bag until you are ready to install it.
5. For plug-in equipment, the power outlet socket must be located near the equipment and must be easily accessible.
6. Keep the board away from humidity.
7. Put the board on a stable surface. Dropping it or letting it fall may cause damage.
8. Wear anti-static wrist strap.
9. Do all preparation work on a static-free surface.
10. Make sure the voltage of the power source is correct before connecting the equipment to the power outlet.
11. Hold the board only by its edges. Be careful not to touch any of the components, contacts or connections.
12. All cautions and warnings on the board should be noted.
13. Use the correct mounting screws and do not over tighten the screws.
14. Keep the original packaging and the anti-static bag; in case the board has to be returned for repair or replacement.

Technical Support and Assistance

1. For the most updated information of NEXCOM products, visit NEXCOM's website at www.nexcom.com.
2. For technical issues that require contacting our technical support team or sales representative, please have the following information ready before calling:
 - Product name and serial number
 - Detailed information of the peripheral devices
 - Detailed information of the installed software (operating system, version, application software, etc.)
 - A complete description of the problem
 - The exact wordings of the error messages

Warning!

1. Handling the unit: carry the unit with both hands and handle it with care.
2. Maintenance: to keep the unit clean, use only approved cleaning products or clean with a dry cloth.

Conventions Used in this Manual



Warning:

Information about certain situations, which if not observed, can cause personal injury. This will prevent injury to yourself when performing a task.



Caution:

Information to avoid damaging components or losing data.



Note:

Provides additional information to complete a task easily.

Global Service Contact Information

Headquarters

NEXCOM International Co., Ltd.

9F, No. 920, Chung-Cheng Rd.,
ZhongHe District, New Taipei City, 23586,
Taiwan, R.O.C.

Tel: +886-2-8226-7786

Fax: +886-2-8226-7782

www.nexcom.com

Asia

Taiwan

NexAIoT Co., Ltd.

Taipei Office

13F, No.920, Chung-Cheng Rd.,
ZhongHe District,
New Taipei City, 23586, Taiwan, R.O.C.

Tel: +886-2-8226-7796

Fax: +886-2-8226-7792

Email: sales@nexcom.com.tw

www.nexcom.com.tw

NexAIoT Co., Ltd.

Taichung Office

16F, No.250, Sec. 2, Chongde Rd.,
Beitun Dist.,

Taichung City 406, R.O.C.

Tel: +886-4-2249-1179

Fax: +886-4-2249-1172

Email: sales@nexcom.com.tw

www.nexcom.com.tw

NexCOBOT Taiwan Co., Ltd.

13F, No.916, Chung-Cheng Rd.,
ZhongHe District,
New Taipei City, 23586, Taiwan, R.O.C.

Tel: +886-2-8226-7796

Fax: +886-2-8226-7792

Email: sales@nexcom.com.tw

www.nexcom.com.tw

GreenBase Technology Corp.

13F, No.922, Chung-Cheng Rd.,
Zhonghe Dist.,
New Taipei City, 23586, Taiwan, R.O.C.

Tel: +886-2-8226-7786

Fax: +886-2-8226-7900

Email: sales@nexcom.com.tw

www.nexcom.com.tw

China

NEXSEC Incorporated

Floor 5, No.4, No.7 fengxian middle Rd.,
(Beike Industrial Park), Haidian District,
Beijing, 100094, China

Tel: +86-10-5704-2680

Fax: +86-10-5704-2681

Email: sales@nexcom.cn

www.nexcom.cn

NEXCOM Shanghai

Room 603/604, Huiyinmingzun Plaza Bldg., 1,
No. 609, Yunlin East Rd.,
Shanghai, 200062, China
Tel: +86-21-5278-5868
Fax: +86-21-3251-6358
Email: sales@nexcom.cn
www.nexcom.cn

NEXCOM Surveillance Technology Corp.

Floor 5, Building C, ZhenHan Industrial Zone,
GanKeng Community, Buji Street,
LongGang District,
ShenZhen, 518112, China
Tel: +86-755-8364-7768
Fax: +86-755-8364-7738
Email: steveyang@nexcom.com.tw
www.nexcom.cn

NEXCOM United System Service

Room 603/604, Huiyinmingzun Plaza Bldg. 1,
No. 609, Yunlin East Rd.,
Shanghai, 200062, China
Tel: +86-21-5278-5868
Fax: +86-21-3251-6358
Email: renwang@nexcom.com.tw
www.nexcom.cn

NEXGOL

1st Floor, Building B4, Electronic 2nd Area,
(Phoenix Lake Industrial Park), Yongchuan Dist.,
Chongqing City, 402160, China
Tel: +86-23-4960-9080
Fax: +86-23-4966-5855
Email: sales@nexcobot.com
www.nexgol.com/NexGoL

Beijing NexGemo Technology Co.,Ltd.

5th Floor, Gemotech Building, No.1, Development Rd.,
Changping International Information Industry Base,
Changping District,
Beijing, 102206, China
Tel: +86-10-8190-9399
Fax: +86-10-8190-9456

Japan**NEXCOM Japan**

9F, Tamachi Hara Bldg.,
4-11-5, Shiba Minato-ku,
Tokyo, 108-0014, Japan
Tel: +81-3-5419-7830
Fax: +81-3-5419-7832
Email: sales@nexcom-jp.com
www.nexcom-jp.com

Europe**United Kingdom
NEXCOM EUROPE**

10 Vincent Avenue,
Crownhill Business Centre,
Milton Keynes, Buckinghamshire
MK8 0AB, United Kingdom
Tel: +44-1908-267121
Fax: +44-1908-262042
Email: sales.uk@nexcom.eu
www.nexcom.eu

**America
USA****NEXCOM USA**

2883 Bayview Drive,
Fremont CA 94538, USA
Tel: +1-510-656-2248
Fax: +1-510-656-2158
Email: sales@nexcom.com
www.nexcom.com

Package Contents

Before continuing, verify that the NEX 812 package that you received is complete. Your package should have all the items listed in the following table.

Item	Name	Qty
1	NEX 812 Motherboard	1
2	SATA Cable	1
3	COM Port Cable	1
4	I/O Shield	1
5	Driver CD	1

Ordering Information

The following information below provides ordering information for NEX 812.

NEX 812 (P/N: 6879G0008120F)

Micro-ATX Form Factor, 6th/7th Generation Intel® Core™ LGA1151 Processor, Q170, LGA1151, DDR4 x4 up to 64GB, 2 x HDMI, 1 x DVI-I, 10 x USB 3.0, 4 x USB 2.0, 2 x GbE, 6 x SATAIII, 5 x RS232, 1 x RS232/422/485, 1 x PCIe x16, 1 x PCIe x4, 1 x PCI

CHAPTER 1: PRODUCT INTRODUCTION

Overview



Key Features

- 7th/6th Generation Intel® Core™ i7/i5/i3/Pentium®/Celeron® processors, 14nm, LGA1151 socket, PCH Q170
- 4 x U-DIMM DDR4 with ECC or non-ECC SO-DIMM 2133/1867MHz, up to 64GB
- Support Multi Display DVI-I+HDMI, HDMI+HDMI
- 2 x Intel® GbE LAN ports, 10 x USB 3.0, 4 x USB 2.0, 5 x RS232, 1 x RS232/485/422, 6 x SATAIII, HD Audio
- 1 x PCIe x16, 1 x PCIe x4, 1 x PCIe x1, 1 x PCI
- 8 Bit DIO, TPM (optional)

Hardware Specifications

CPU Support

- 6th/7th Generation Intel® Core™ Processors, socket LGA1151

Chipset

- Intel® Q170 Express Chipset

Main Memory

- 4 x DDR4 U-DIMM memory sockets with non-ECC support, up to 64 GB 2133/1876MHz

BIOS

- AMI (UEFI)

Display

- Integrated Intel® Graphics
 - 1 x DVI-I connector (resolution up to 1920 x 1080 @ 60Hz)
 - VGA (resolution up to 1920 x 1080 @ 60Hz)
- 1 x HDMI1.4 connector (resolution up to 4096 x 2304 @ 30MHz)

System

- 1 x PS/2 connector, 10 x USB 3.0, 4 x USB 2.0
- 5 x RS232, 1 x RS232/485/422 & supports 5/12V on RI pin (COM1)
- Realtek ALC887 5.1 Channel HDA codec, Internal SPKR
- 1 x Front panel header, 8-bit digital I/O (programmable input/output), WDT
- Supports onboard TPM (optional)
- 3 x Smart fan connectors

Storage

- 6 x SATA III (6.0Gb/s) ports, support RAID 0/1/5/10

Expansion Slots

- 1 x PCIe 3.0/2.0 [x16], 1 x PCIe 3.0/2.0 [x4] Slot (open edge), 1 x PCIe 3.0/2.0 [x1] Slot (open edge), 1 x PCI

Rear I/O

- 1 x PS/2 combo port (keyboard and mouse support)
- 10 x USB 3.0, 2 x USB 2.0
- 1 x DVI-I, 2 x HDMI
- 1 x COM (COM1)
- 2 x RJ45:
 - LAN 1: Intel® PHY i219LM GbE LAN (supports iAMT 11.0)
 - LAN 2: Intel® i211AT GbE LAN
- 1 x HD Audio connector (1 x line-out + mic + line-in 3.5mm jack)

Internal I/O

- 4 x USB 2.0
- 5 x RS232
- HD Audio:
 - 1 x Audio pin header (speaker header x 1 [line-out])

Power Requirement

- 1 x 24-pin ATX power connector
- 1 x 8-pin (2x4) ATX 12V power connector

Dimensions

- Micro-ATX form factor
- Dimension: 244mm (L) x 244mm (W) (9.6" x 9.6")

Environment

- Board level operating temperature: 0°C to 60°C
- Storage temperature: -40°C to 85°C
- Relative humidity:
 - 10% to 95% (operating, non-condensing)
 - 5% to 95% (non-operating, non-condensing)

Certifications

- Meet CE/FCC Class A

Knowing Your NEX 812

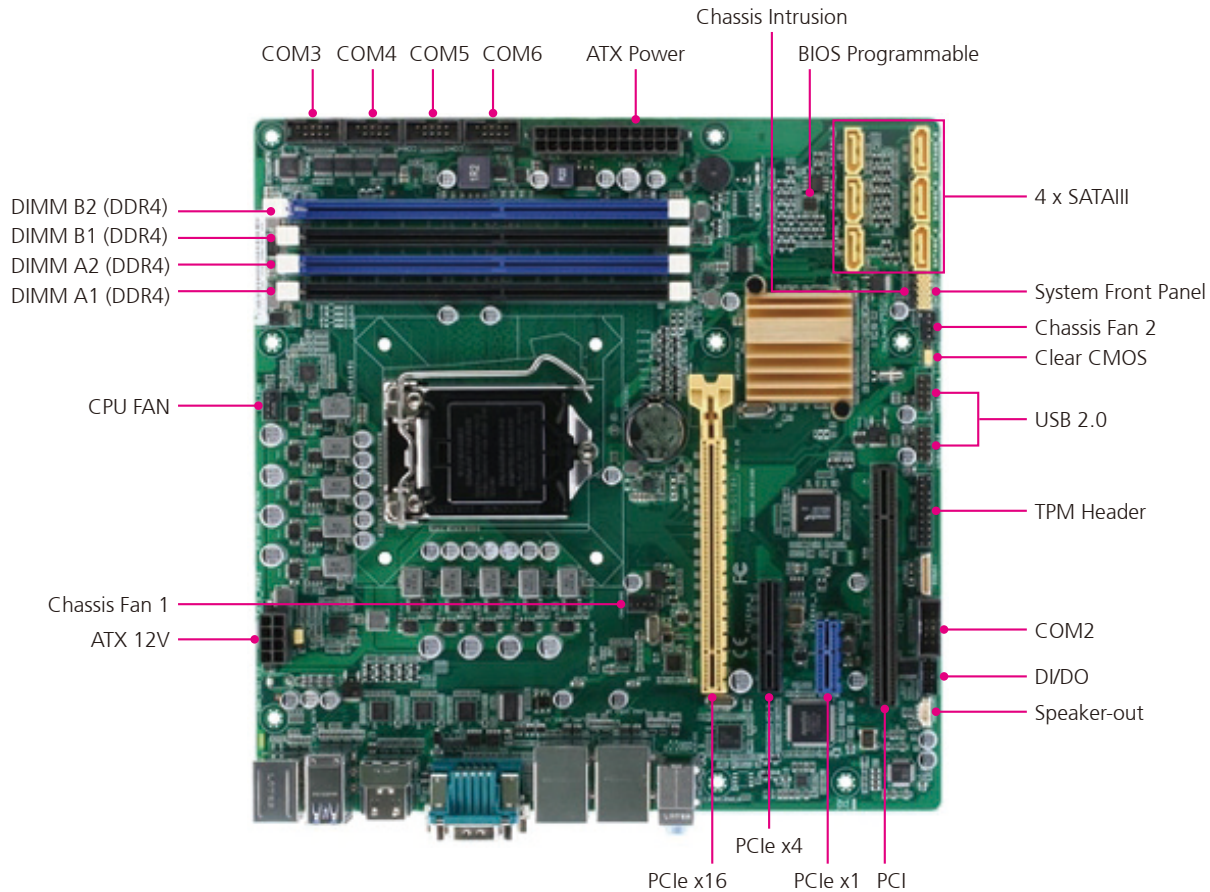

Edge I/O View

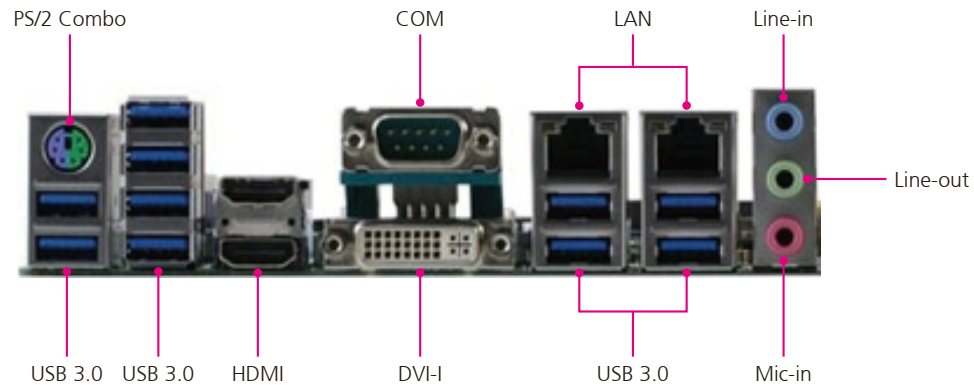

CHAPTER 2: JUMPERS AND CONNECTORS

This chapter describes how to set the jumpers and connectors on the NEX 812 motherboard.

Before You Begin

- Ensure you have a stable, clean working environment. Dust and dirt can get into components and cause a malfunction. Use containers to keep small components separated.
- Adequate lighting and proper tools can prevent you from accidentally damaging the internal components. Most of the procedures that follow require only a few simple tools, including the following:
 - A Philips screwdriver
 - A flat-tipped screwdriver
 - A set of jewelers screwdrivers
 - A grounding strap
 - An anti-static pad
- Using your fingers can disconnect most of the connections. It is recommended that you do not use needle-nosed pliers to disconnect connections as these can damage the soft metal or plastic parts of the connectors.
- Before working on internal components, make sure that the power is off. Ground yourself before touching any internal components, by touching a metal object. Static electricity can damage many of the electronic components. Humid environments tend to have less static electricity than

dry environments. A grounding strap is warranted whenever danger of static electricity exists.

Precautions

Computer components and electronic circuit boards can be damaged by discharges of static electricity. Working on computers that are still connected to a power supply can be extremely dangerous.

Follow the guidelines below to avoid damage to your computer or yourself:

- Always disconnect the unit from the power outlet whenever you are working inside the case.
- If possible, wear a grounded wrist strap when you are working inside the computer case. Alternatively, discharge any static electricity by touching the bare metal chassis of the unit case, or the bare metal body of any other grounded appliance.
- Hold electronic circuit boards by the edges only. Do not touch the components on the board unless it is necessary to do so. Don't flex or stress the circuit board.
- Leave all components inside the static-proof packaging that they shipped with until they are ready for installation.
- Use correct screws and do not over tighten screws.

Jumper Settings

A jumper is the simplest kind of electric switch. It consists of two metal pins and a cap. When setting the jumpers, ensure that the jumper caps are placed on the correct pins. When the jumper cap is placed on both pins, the jumper is short. If you remove the jumper cap, or place the jumper cap on just one pin, the jumper is open.

Refer to the illustrations below for examples of what the 2-pin and 3-pin jumpers look like when they are short (on) and open (off).

Two-Pin Jumpers: Open (Left) and Short (Right)

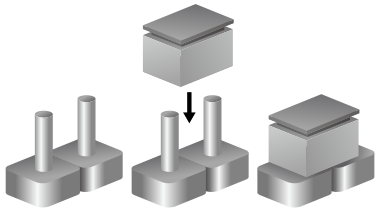

Three-Pin Jumpers: Pins 1 and 2 are Short

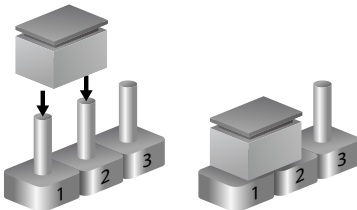

Locations of the Jumpers and Connectors

The figure below shows the location of the jumpers and connectors.

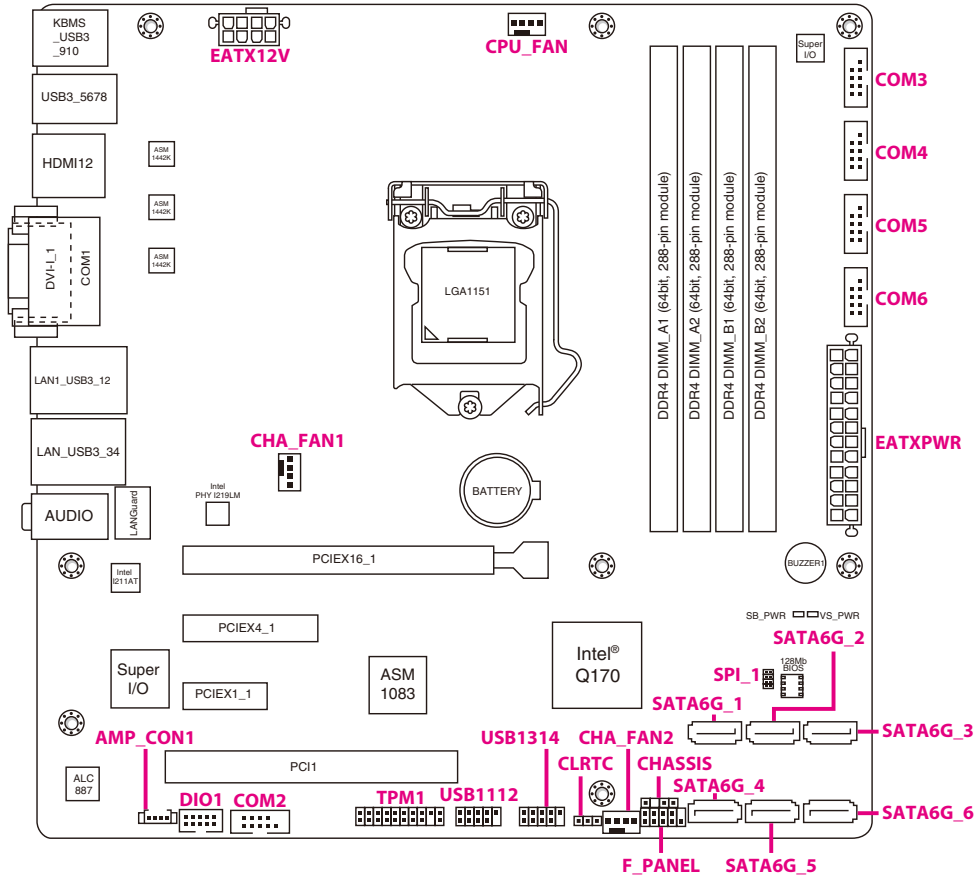

Jumpers

CMOS Clear Selection

Connector type: 1x3 3-pin header

Connector location: CLRTC



Pin	Settings
1-2 On	Normal
2-3 On	Clear CMOS

1-2 On: default

Chassis Intrusion

Connector type: 1x4 4-pin header

Connector location: CHASSIS



Pin	Definition
1	+5VSB_MB
2	NA
3	Chassis Signal
4	GND

3-4 On: default

Connector Pin Definitions

24-pin ATX Power Connector

Connector type: 2x12 24-pin boxed header
Connector location: EATXPWR

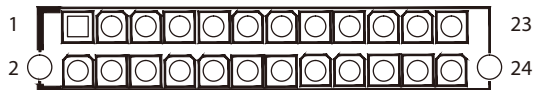

Pin	Definition	Pin	Definition
1	+3 Volts	2	+3 Volts
3	+3 Volts	4	-12 Volts
5	GND	6	GND
7	+5 Volts	8	PSON#
9	GND	10	GND
11	+5 Volts	12	GND
13	GND	14	GND
15	Power OK	16	-5 Volts
17	+5V Standby	18	+5 Volts
19	+12 Volts	20	+5 Volts
21	+12 Volts	22	+5 Volts
23	+3 Volts	24	GND

8-pin ATX Power Connector

Connector type: 2x4 8-pin boxed header
Connector location: EATX12V

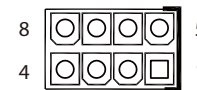

Pin	Definition	Pin	Definition
1	GND	2	+12V DC
3	GND	4	+12V DC
5	GND	6	+12V DC
7	GND	8	+12V DC

TPM Header

Connector type: 2x10 20-pin header

Connector location: TPM1

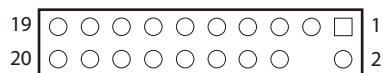

Pin	Definition	Pin	Definition
1	LCLK	2	GND
3	LFRAME#	4	
5	PCIRST#	6	NC
7	LAD3	8	LAD2
9	+3V	10	LAD1
11	LAD0	12	GND
13	NC	14	NC
15	+3VSB	16	SERIRQ
17	GND	18	CLKRUN#
19	LPCPD#	20	NC

CPU Fan Connector

Connector type: 1x4 4-pin header

Connector location: CPU_FAN



Pin	Definition	Pin	Definition
1	GND	2	CPU FAN PWR
3	CPU FAN IN	4	CPU FAN PWM

Chassis Fan Connectors

Connector type: 1x4 4-pin header

Connector location: CHA_FAN1 and CHA_FAN2



Pin	Definition	Pin	Definition
1	GND	2	CHA FAN PWR
3	CHA FAN IN	4	+5V

BIOS Programmable Connector

Connector type: 2x4 8-pin header

Connector location: SPI_1

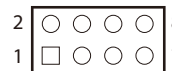

Pin	Definition	Pin	Definition
1	+V3.3SPI	2	GND
3	SPI_CS0#_F	4	SPI_CLK_F
5	SPI_SO_F	6	SPI_SI_F
7	NC	8	NC

System Panel Connector

Connector type: 2x5 10-pin header

Connector location: F_PANEL

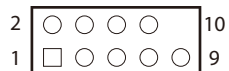

Pin	Definition	Pin	Definition
1	HDD_LED+	2	PWR_LED+
3	HDD_LED-	4	PWR_LED-
5	Ground	6	PWR
7	HWRST#	8	GND
9	NC	10	

Digital I/O Connector

Connector type: 2x5 10-pin header

Connector location: DIO1

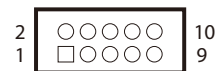

Pin	Definition	Pin	Definition
1	DIO_I#1	2	DIO_I#2
3	DIO_I#3	4	DIO_I#4
5	DIO_O#1	6	DIO_O#2
7	DIO_O#3	8	DIO_O#4
9	+5V	10	GND

COM2 to COM6 Internal Serial Port Connectors

Connector type: 2x5 10-pin header

Connector location: COM2, COM3, COM4, COM5 and COM6

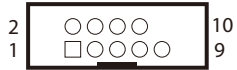

Pin	Definition	Pin	Definition
1	DCD	2	RXD
3	TXD	4	DTR
5	GND	6	DSR
7	RTS	8	CTS
9	RI	10	

Serial ATA 6.0Gb/s Connector 1

Connector type: Standard Serial ATA 7P (1.27mm, SATA-M-180)

Connector location: SATA6G_1

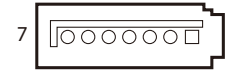

Pin	Definition	Pin	Definition
1	GND	2	RSATA_TXP1
3	RSATA_TXN1	4	GND
5	RSATA_RXN1	6	RSATA_RXP1
7	GND		

Serial ATA 6.0Gb/s Connector 2

Connector type: Standard Serial ATA 7P (1.27mm, SATA-M-180)

Connector location: SATA6G_2



Pin	Definition	Pin	Definition
1	GND	2	RSATA_TXP2
3	RSATA_TXN2	4	GND
5	RSATA_RXN2	6	RSATA_RXP2
7	GND		

Serial ATA 6.0Gb/s Connector 3

Connector type: Standard Serial ATA 7P (1.27mm, SATA-M-180)

Connector location: SATA6G_3

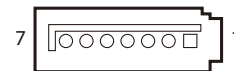

Pin	Definition	Pin	Definition
1	GND	2	RSATA_TXP3
3	RSATA_TXN3	4	GND
5	RSATA_RXN3	6	RSATA_RXP3
7	GND		

Serial ATA 6.0Gb/s Connector 4

Connector type: Standard Serial ATA 7P (1.27mm, SATA-M-180)

Connector location: SATA6G_4



Pin	Definition	Pin	Definition
1	GND	2	RSATA_TXP4
3	RSATA_TXN4	4	GND
5	RSATA_RXN4	6	RSATA_RXP4
7	GND		

Serial ATA 6.0Gb/s Connector 5

Connector type: Standard Serial ATA 7P (1.27mm, SATA-M-180)

Connector location: SATA6G_5

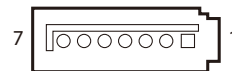

Pin	Definition	Pin	Definition
1	GND	2	RSATA_TXP5
3	RSATA_TXN5	4	GND
5	RSATA_RXN5	6	RSATA_RXP5
7	GND		

Serial ATA 6.0Gb/s Connector 6

Connector type: Standard Serial ATA 7P (1.27mm, SATA-M-180)

Connector location: SATA6G_6



Pin	Definition	Pin	Definition
1	GND	2	RSATA_TXP6
3	RSATA_TXN6	4	GND
5	RSATA_RXN6	6	RSATA_RXP6
7	GND		

USB 2.0 Connector

Connector type: 2x5 10-pin header

Connector location: USB1112

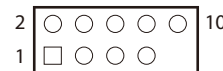

Pin	Definition	Pin	Definition
1	USB+5V	2	USB+5V
3	USB_P11-	4	USB_P12-
5	USB_P11+	6	USB_P12+
7	GND	8	GND
9		10	NC

USB 2.0 Connector

Connector type: 2x5 10-pin header

Connector location: USB1314

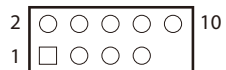

Pin	Definition	Pin	Definition
1	USB+5V	2	USB+5V
3	USB_P13-	4	USB_P14-
5	USB_P13+	6	USB_P14+
7	GND	8	GND
9		10	NC

Speaker-out Connector

Connector type: 1x4 4-pin header

Connector location: AMP_CON1



Pin	Definition	Pin	Definition
1	R_OUT+	2	R_OUT-
3	L_OUT-	4	L_OUT+

Block Diagram

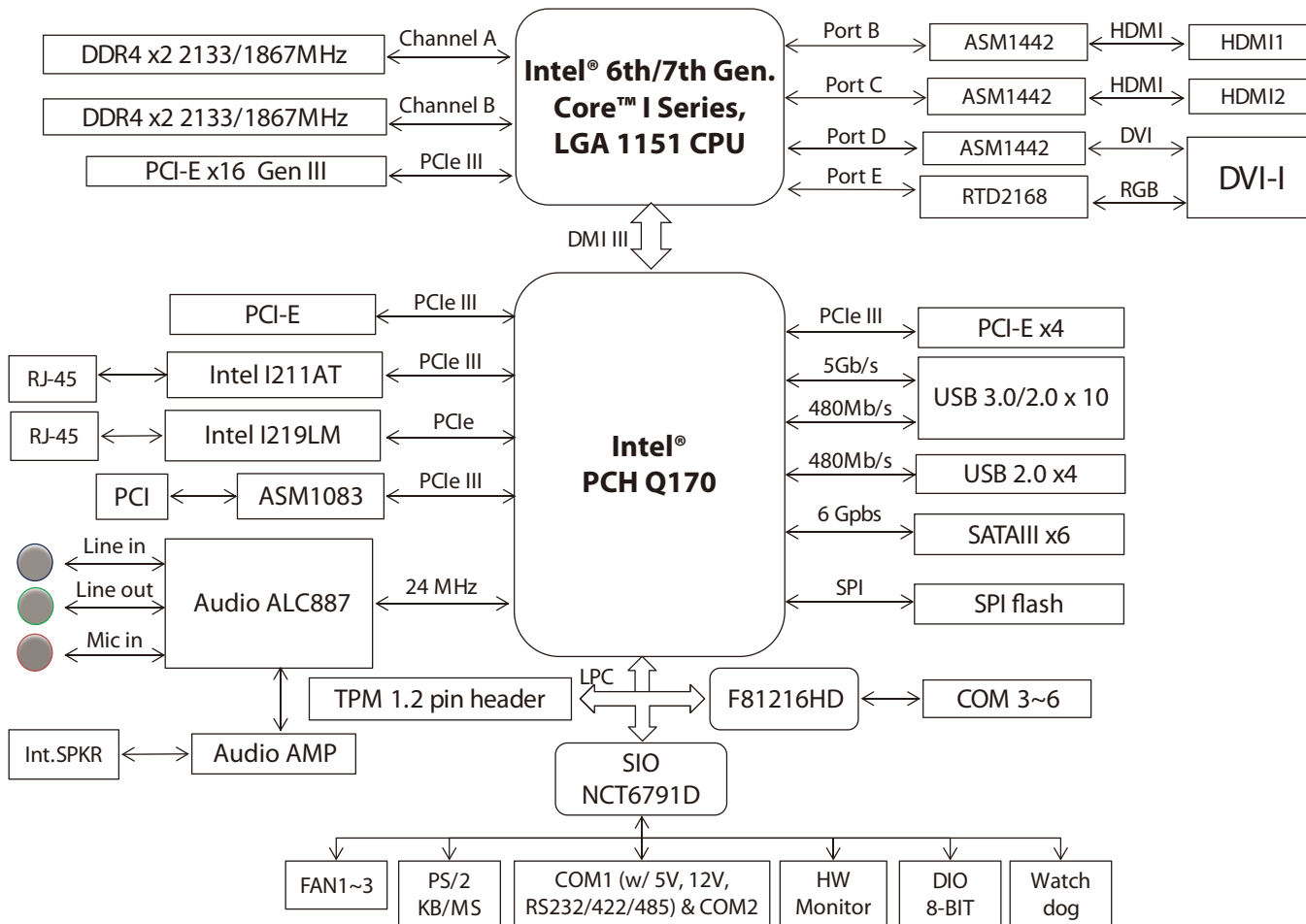

CHAPTER 3: BIOS SETUP

This chapter describes how to use the BIOS setup program for NEX 812. The BIOS screens provided in this chapter are for reference only and may change if the BIOS is updated in the future.

To check for the latest updates and revisions, visit the NEXCOM website at www.nexcom.com.tw.

About BIOS Setup

The BIOS (Basic Input and Output System) Setup program is a menu driven utility that enables you to make changes to the system configuration and tailor your system to suit your individual work needs. It is a ROM-based configuration utility that displays the system's configuration status and provides you with a tool to set system parameters.

These parameters are stored in non-volatile battery-backed-up CMOS RAM that saves this information even when the power is turned off. When the system is turned back on, the system is configured with the values found in CMOS.

With easy-to-use pull down menus, you can configure such items as:

- Hard drives, diskette drives, and peripherals
- Video display type and display options
- Password protection from unauthorized use
- Power management features

The settings made in the setup program affect how the computer performs. It is important, therefore, first to try to understand all the setup options, and second, to make settings appropriate for the way you use the computer.

When to Configure the BIOS

This program should be executed under the following conditions:

- When changing the system configuration
- When a configuration error is detected by the system and you are prompted to make changes to the setup program
- When resetting the system clock
- When redefining the communication ports to prevent any conflicts
- When making changes to the Power Management configuration
- When changing the password or making other changes to the security setup

Normally, CMOS setup is needed when the system hardware is not consistent with the information contained in the CMOS RAM, whenever the CMOS RAM has lost power, or the system features need to be changed.

Default Configuration

Most of the configuration settings are either predefined according to the Load Optimal Defaults settings which are stored in the BIOS or are automatically detected and configured without requiring any actions. There are a few settings that you may need to change depending on your system configuration.

Entering Setup











When the system is powered on, the BIOS will enter the Power-On Self Test (POST) routines. These routines perform various diagnostic checks; if an error is encountered, the error will be reported in one of two different ways:

- If the error occurs before the display device is initialized, a series of beeps will be transmitted.
- If the error occurs after the display device is initialized, the screen will display the error message.

Powering on the computer and immediately pressing allows you to enter Setup.

Press the  key to enter Setup:

Legends

Key	Function
	Moves the highlight left or right to select a menu.
	Moves the highlight up or down between sub-menu or fields.
	Exits the BIOS Setup Utility.
	Scrolls forward through the values or options of the highlighted field.
	Scrolls backward through the values or options of the highlighted field.
	Selects a field.
	Displays General Help.
	Load previous values.
	Load optimized default values.
	Saves and exits the Setup program.
	Press <Enter> to enter the highlighted sub-menu

Scroll Bar

When a scroll bar appears to the right of the setup screen, it indicates that there are more available fields not shown on the screen. Use the up and down arrow keys to scroll through all the available fields.

Submenu

When “▶” appears on the left of a particular field, it indicates that a submenu which contains additional options are available for that field. To display the submenu, move the highlight to that field and press  .

BIOS Setup Utility

Once you enter the AMI BIOS Setup Utility, the Main Menu will appear on the screen. The main menu allows you to select from several setup functions and one exit. Use arrow keys to select among the items and press  to accept or enter the submenu.

Main

The Main menu is the first screen that you will see when you enter the BIOS Setup Utility.

System Date

The date format is <day>, <month>, <date>, <year>. Day displays a day, from Monday to Sunday. Month displays the month, from January to December. Date displays the date, from 1 to 31. Year displays the year, from 2005 to 2099.

System Time

The time format is <hour>, <minute>, <second>. The time is based on the 24-hour military-time clock. For example, 1 p.m. is 13:00:00. Hour displays hours from 00 to 23. Minute displays minutes from 00 to 59. Second displays seconds from 00 to 59.



Advanced

The Advanced menu allows you to configure your system for basic operation. Some entries are defaults required by the system board, while others, if enabled, will improve the performance of your system or let you set some features according to your preference.



Setting incorrect field values may cause the system to malfunction.



CPU Configuration

This section is used to configure the CPU settings.

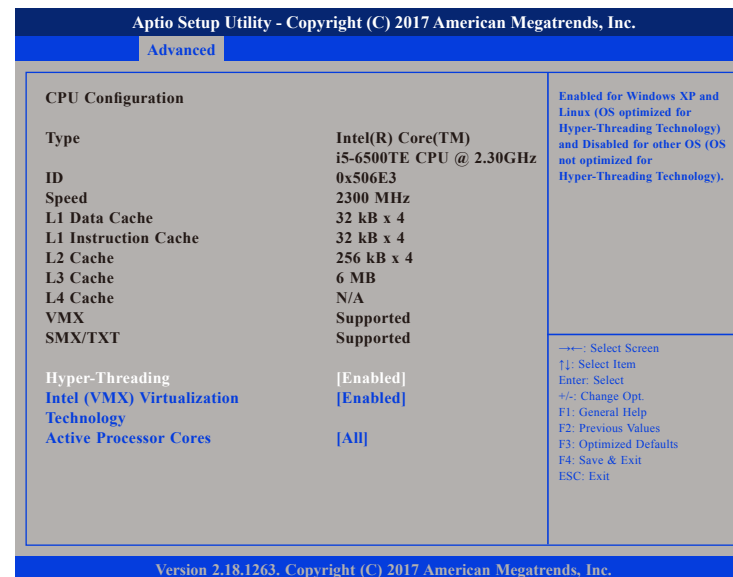

Hyper-Threading

Enables or disables hyper-threading technology.

Intel® (VMX) Virtualization Technology

When this field is set to Enabled, the VMM can utilize the additional hardware capabilities provided by Vanderpool Technology.

Active Processor Cores

Select the number of cores to enable in each processor package.

Trusted Computing

This section is used to configure Trusted Platform Module (TPM) settings.



Security Device Support

Enables or disables BIOS support for security device. O.S will not show Security Device. TCG EFI protocol and INT1A interface will not be available.

SATA Configuration

This section displays information of the SATA drives.



SATA Controller(s)

Enables or disables SATA device.

SATA Mode Selection

Configures the SATA controller as AHCI or RAID mode.

Port 1 to Port 6

Enables or disables SATA port 1, port 2, port 3, port 4, port 5 or port 6.

Hot Plug

Enables or disables hot plugging feature on SATA port 1, port 2, port 3, port 4, port 5 or port 6.

PCH-FW Configuration

This section is used to configure the firmware update options.

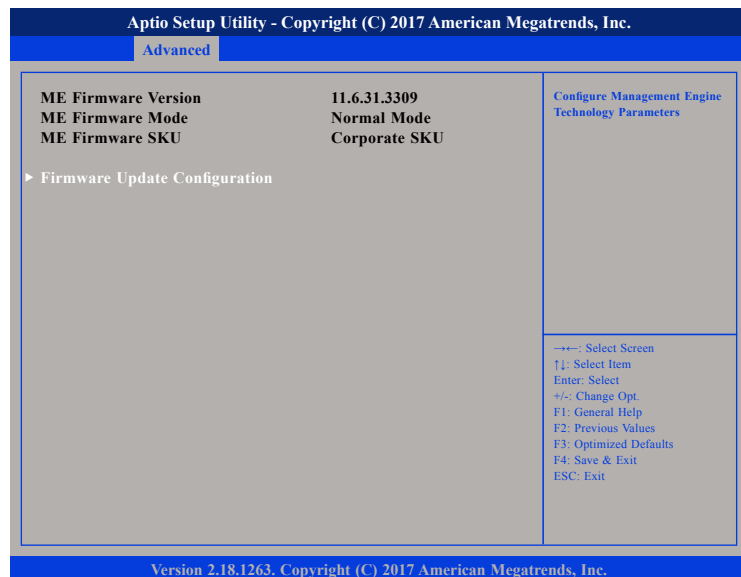

Firmware Update Configuration

Enters the Firmware Update Configuration submenu.

Firmware Update Configuration



Me FW Image Re-Flash

Enables or disables the ME firmware image re-flash function.

SIO Configuration

This section is used to configure the serial ports.

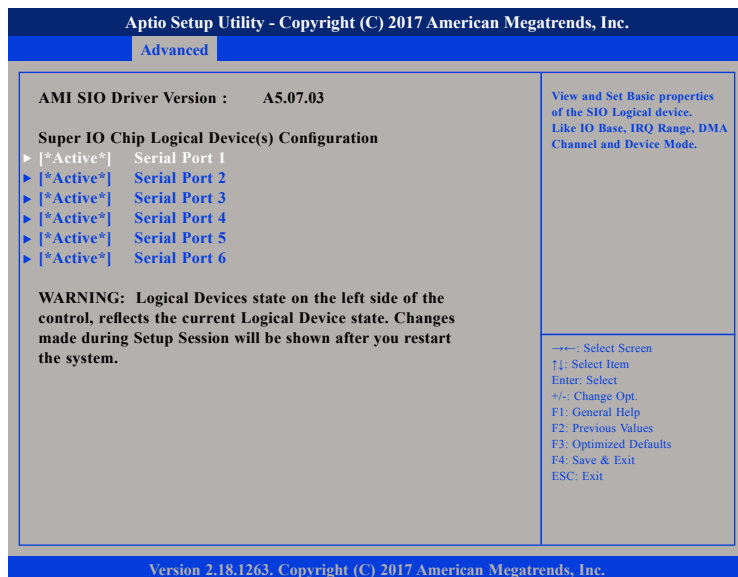

[*Active*] Serial Port 1 to [*Active*] Serial Port 6

Enters the submenu of [*Active*] Serial Port 1 to [*Active*] Serial Port 6.

[*Active*] Serial Port 1

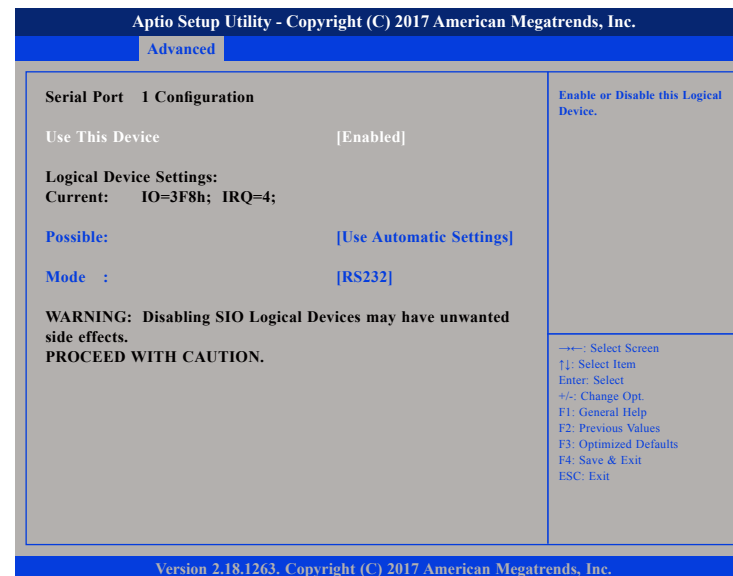

Use This Device

Enables or disables the serial port.

Possible:

Configures the base address for the serial port.

Mode

Configures the serial port mode to RS232, RS422 or RS485.

[*Active*] Serial Port 2



Use This Device

Enables or disables the serial port.

Possible:

Configures the base address for the serial port.

[*Active*] Serial Port 3

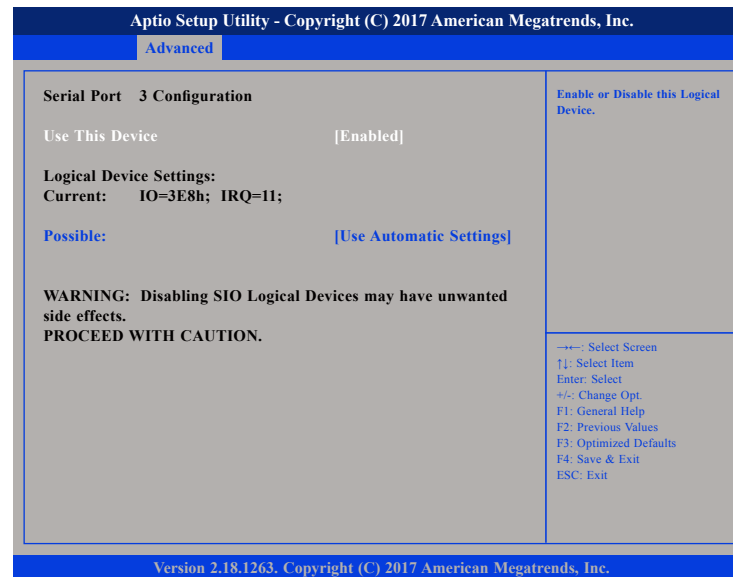

Use This Device

Enables or disables the serial port.

Possible:

Configures the base address for the serial port.

[*Active*] Serial Port 4

Aptio Setup Utility - Copyright (C) 2017 American Megatrends, Inc.	
Advanced	
Serial Port 4 Configuration Use This Device [Enabled] Logical Device Settings: Current: IO=2E8h; IRQ=11; Possible: [Use Automatic Settings]	Enable or Disable this Logical Device. →←: Select Screen ↑↓: Select Item Enter: Select +/-: Change Opt. F1: General Help F2: Previous Values F3: Optimized Defaults F4: Save & Exit ESC: Exit
WARNING: Disabling SIO Logical Devices may have unwanted side effects. PROCEED WITH CAUTION.	
Version 2.18.1263. Copyright (C) 2017 American Megatrends, Inc.	

Use This Device

Enables or disables the serial port.

Possible:

Configures the base address for the serial port.

[*Active*] Serial Port 5

Aptio Setup Utility - Copyright (C) 2017 American Megatrends, Inc.	
Advanced	
Serial Port 5 Configuration Use This Device [Enabled] Logical Device Settings: Current: IO=2D0h; IRQ=11; Possible: [Use Automatic Settings]	Enable or Disable this Logical Device. →←: Select Screen ↑↓: Select Item Enter: Select +/-: Change Opt. F1: General Help F2: Previous Values F3: Optimized Defaults F4: Save & Exit ESC: Exit
WARNING: Disabling SIO Logical Devices may have unwanted side effects. PROCEED WITH CAUTION.	
Version 2.18.1263. Copyright (C) 2017 American Megatrends, Inc.	

Use This Device

Enables or disables the serial port.

Possible:

Configures the base address for the serial port.

[*Active*] Serial Port 6

Aptio Setup Utility - Copyright (C) 2017 American Megatrends, Inc.	
Advanced	
Serial Port 6 Configuration	
Use This Device	[Enabled]
Logical Device Settings:	
Current:	IO=2C0h; IRQ=11;
Possible:	[Use Automatic Settings]
WARNING: Disabling SIO Logical Devices may have unwanted side effects. PROCEED WITH CAUTION.	
--- Select Screen ↑ Select Item Enter: Select +/- Change Opt. F1: General Help F2: Previous Values F3: Optimized Defaults F4: Save & Exit ESC: Exit	
Version 2.18.1263. Copyright (C) 2017 American Megatrends, Inc.	

Use This Device

Enables or disables the serial port.

Possible:

Configures the base address for the serial port.

Hardware Monitor

This section is used to monitor hardware status such as temperature, fan speed and voltages.

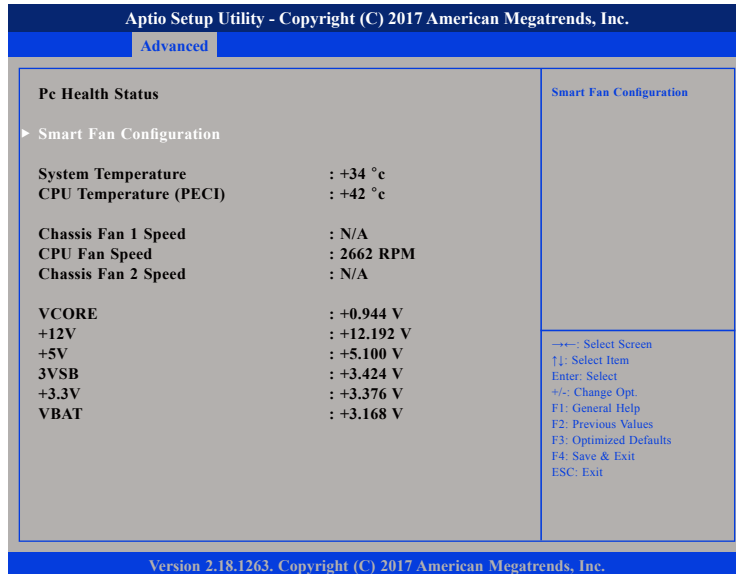

The screenshot shows the BIOS 'Advanced' menu with the 'Hardware Monitor' section expanded. It displays various system metrics including temperatures, fan speeds, and voltages. A legend at the bottom right explains the navigation keys.

Pe Health Status		Smart Fan Configuration
▶ Smart Fan Configuration		
System Temperature	: +34 °c	
CPU Temperature (PECI)	: +42 °c	
Chassis Fan 1 Speed	: N/A	
CPU Fan Speed	: 2662 RPM	
Chassis Fan 2 Speed	: N/A	
VCORE	: +0.944 V	
+12V	: +12.192 V	
+5V	: +5.100 V	
3VSB	: +3.424 V	
+3.3V	: +3.376 V	
VBAT	: +3.168 V	

←→: Select Screen
↑↓: Select Item
Enter: Select
+/-: Change Opt.
F1: General Help
F2: Previous Values
F3: Optimized Defaults
F4: Save & Exit
ESC: Exit

Version 2.18.1263. Copyright (C) 2017 American Megatrends, Inc.

CPU Fan Speed

Detects and displays the current CPU fan speed.

VCORE to VBAT

Detects and displays the output voltages.

System Temperature

Detects and displays the current system temperature.

CPU Temperature (PECI)

Detects and displays the current CPU temperature.

Chassis Fan 1 Speed and Chassis Fan 2 Speed

Detects and displays the current chassis fan 1 and fan 2 speed.

Smart Fan Configuration

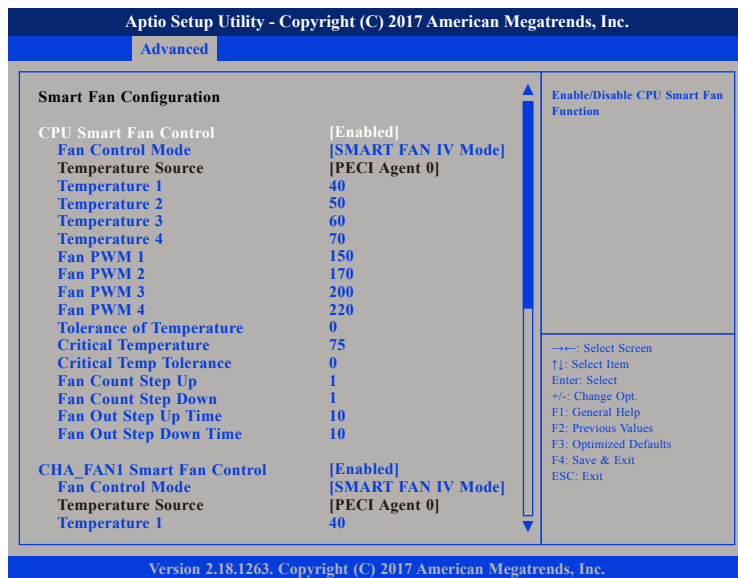

CPU Smart Fan Control

Enables or disables CPU smart fan function.

Fan Control Mode (For CPU Fan)

Configures the fan mode of the CPU fan. The options are Manual Mode, Thermal Cruise Mode (automatic fan mode), Speed Cruise Mode and SMART FAN IV Mode.

Temperature Source (For CPU Fan)

Selects the temperature source.

Temperature 1 to Temperature 4 (For CPU Fan)

Configures the temperature setting.

Fan PWM 1 to Fan PWM 4 (For CPU Fan)

Configures the amount of fan PWN for Smart Fan IV Mode.

Tolerance of Temperature (For CPU Fan)

Configures the tolerance of target temperature.

Critical Temperature (For CPU Fan)

Configures the time that Fan Out requires for reducing its value by one step.

Critical Temp Tolerance (For CPU Fan)

Configures the tolerance of critical temperature.

Fan Count Step Up and Step Down (For CPU Fan)

Configures the value for fan count step up and step down.

Fan Out Step Up Time and Step Down Time (For CPU Fan)

Configures the time that Fan Out requires for increasing (step up time) or reducing (step down time) its value by one step with an interval of 0.1 second.

CHA_FAN1 Smart Fan Control

Enables or disables chassis 1 smart fan function.

Fan Control Mode (For Chassis Fan 1)

Configures the fan mode of the CPU fan. The options are Manual Mode, Thermal Cruise Mode (automatic fan mode), Speed Cruise Mode and SMART FAN IV Mode.

Temperature Source (For Chassis Fan 1)

Selects the temperature source.

Temperature 1 to Temperature 4 (For Chassis Fan 1)

Configures the temperature setting.

Fan PWM 1 to Fan PWM 4 (For Chassis Fan 1)

Configures the amount of fan PWN for Smart Fan IV Mode.

Tolerance of Temperature (For Chassis Fan 1)

Configures the tolerance of target temperature.

Critical Temperature (For Chassis Fan 1)

Configures the time that Fan Out requires for reducing its value by one step.

Critical Temp Tolerance (For Chassis Fan 1)

Configures the tolerance of critical temperature.

Fan Count Step Up and Step Down (For Chassis Fan 1)

Configures the value for fan count step up and step down.

Fan Out Step Up Time and Step Down Time (For Chassis Fan 1)

Configures the time that Fan Out requires for increasing (step up time) or reducing (step down time) its value by one step with an interval of 0.1 second.

USB Configuration

This section is used to configure the USB.

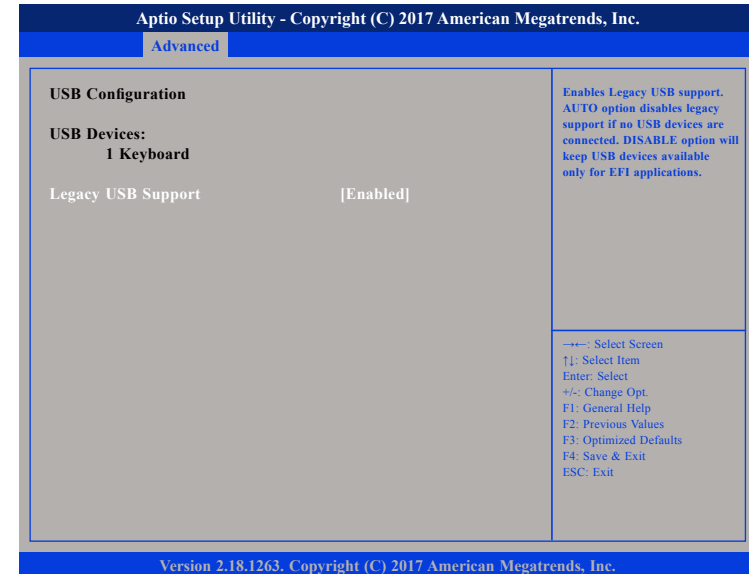

Legacy USB Support

Enable Enables Legacy USB.

Auto Disables support for Legacy when no USB devices are connected.

Disable Keeps USB devices available only for EFI applications.

Digital IO Port Configuration

This section is used to configure digital I/O port settings.

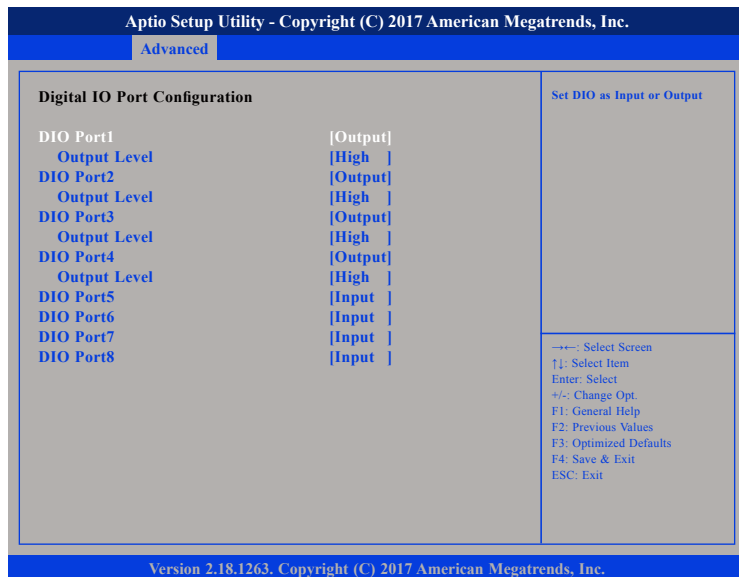

DIO Port1 to DIO Port8

Configures DIO port1 to port8 as input or output.

Output Level

Configures the output level as high or low.

Power Management

This section is used to configure the power management features.



Power Mode

Configures the power mode of the system.

Restore AC Power Loss

Select the AC power state when power is re-applied after a power failure.

RTC wake system from S5

Enables or disables the system to wake up from S5.

Fixed Time: System will wake on the hr:min:sec specified.

Dynamic Time: System will wake on the current time + increase minute(s).



Chipset

This section gives you functions to configure the system based on the specific features of the chipset. The chipset manages bus speeds and access to system memory resources.



System Agent (SA) Configuration

Enters the System Agent (SA) Configuration submenu.

PCH-IO Configuration

Enters the PCH-IO Configuration submenu.

System Agent (SA) Configuration

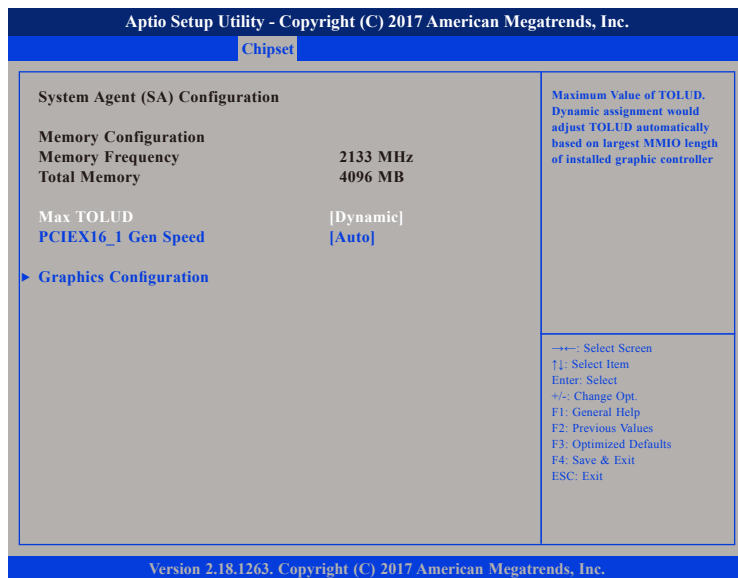

Max TOLUD

Configures the maximum value of TOLUD.

PCIEX16_1 Gen Speed

Configures the maximum link speed of the PEG device.

Graphics Configuration



Primary Display

Select which IGFX/PEG/PCI graphics device should be the primary display or select SG for Switchable Gfx.

Primary IGFX Boot Display

Select the video device which will be activated during POST. Has no effect if external graphics is present. Secondary boot display selection will appear based on your selection. VGA modes will be supported only on primary display.

PCH-IO Configuration



HD Audio

Control detection of the HD Audio device.

Disabled	HD Audio will be unconditionally disabled.
Enabled	HD Audio will be unconditionally enabled.
Auto	HD Audio will be enabled if present, disabled otherwise.

PCIEX1_1 and PCIEX4_1 Gen Speed

Configures the maximum PCIe speed of PCIEX1_1 and PCIEX4_1.

Security

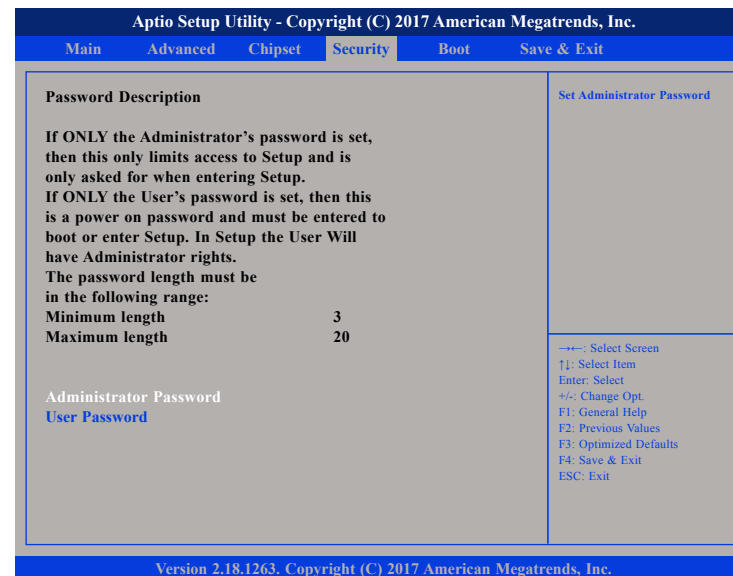

Administrator Password

Select this to reconfigure the administrator's password.

User Password

Select this to reconfigure the user's password.

Boot

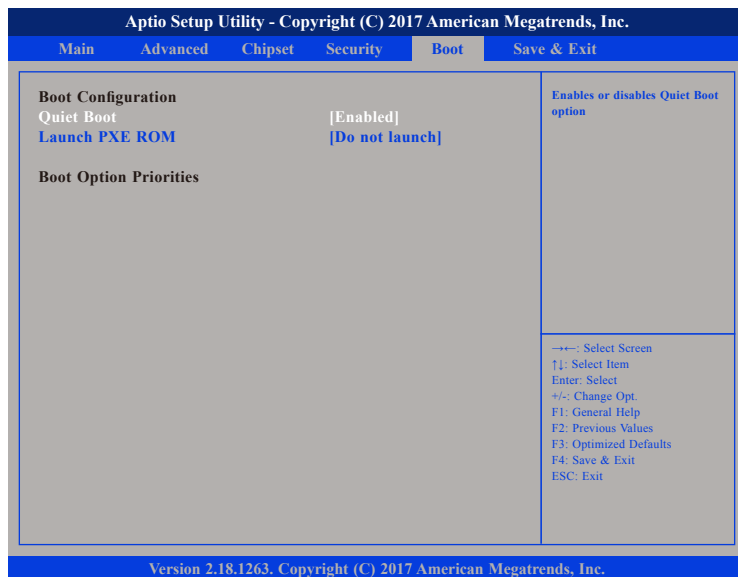

Quiet Boot

Enabled Displays OEM logo instead of the POST messages.
 Disabled Displays normal POST messages.

Launch PXE ROM

Controls the execution of UEFI and legacy PXE OpROM.

Boot Option Priorities

Adjust the boot sequence of the system. Boot Option #1 is the first boot device that the system will boot from, next will be #2 and so forth.

Save & Exit

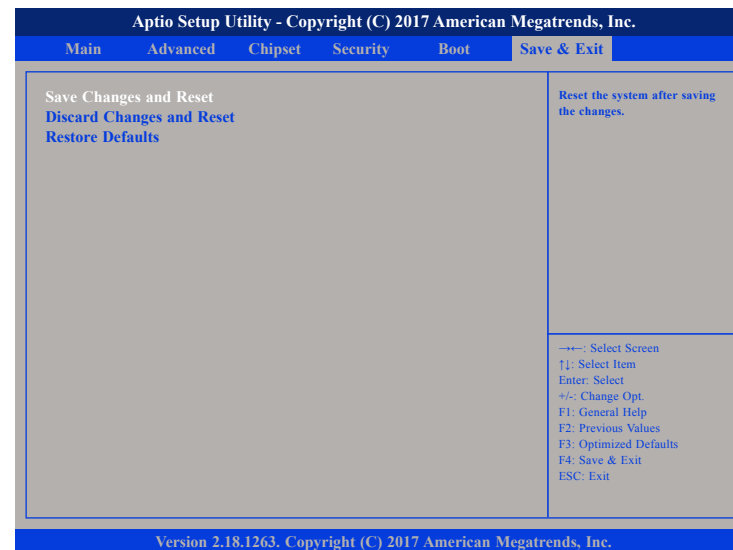

Save Changes and Reset

To save the changes and reset, select this field then press <Enter>. A dialog box will appear. Confirm by selecting Yes.

Discard Changes and Reset

To exit the Setup utility and reset without saving the changes, select this field then press <Enter>. You may be prompted to confirm again before exiting.

Restore Defaults

To restore the BIOS to default settings, select this field then press <Enter>. A dialog box will appear. Confirm by selecting Yes.